

max. 110 °C

10 bar max.

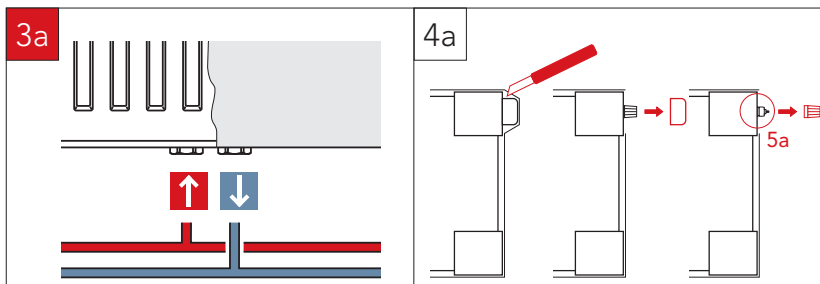

(DE) ACHTUNG: Bei der Montage von Heizkörpern ist zu beachten, dass die Befestigung von Heizkörpern so dimensioniert wird, dass sie für die bestimmungsgemäße Verwendung und vorhersehbarer Fehlanwendung geeignet ist. Hierbei sind insbesondere die Verbindung mit dem Baukörper sowie dessen Beschaffenheit, die Geeignetheit des Montagezubehöres und die möglichen Belastungen nach erfolgter Montage zu prüfen.

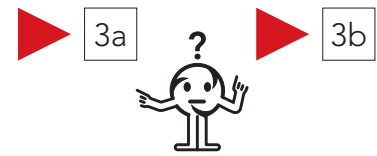
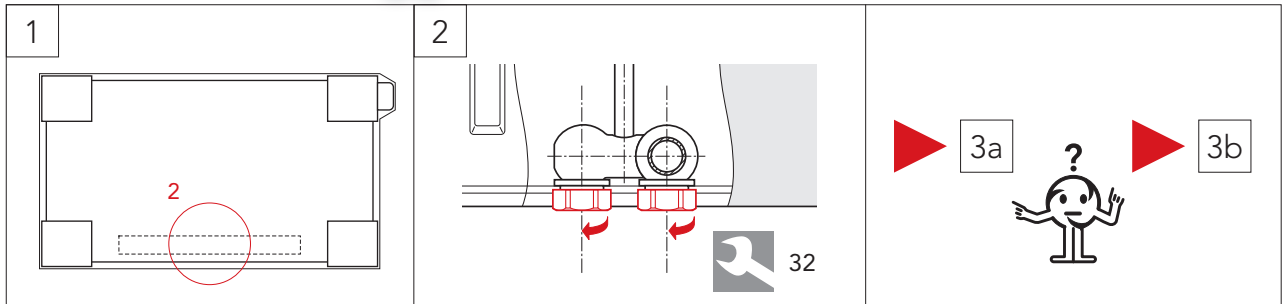
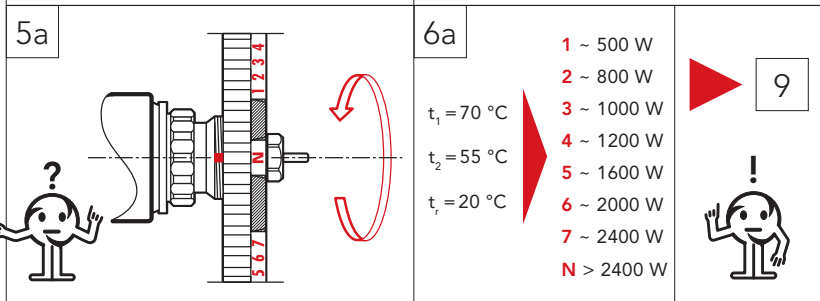

(GB) ATTENTION: For the correct installation of radiators it is essential that the fixing of the radiator is carried out in such a way that it is suitable for intended use AND predictable misuse. A number of elements need to be taken into consideration including the fixing method used to secure the radiator to the wall, the type and condition of the wall itself, and any additional potential forces or weights, prior to finalising installation.

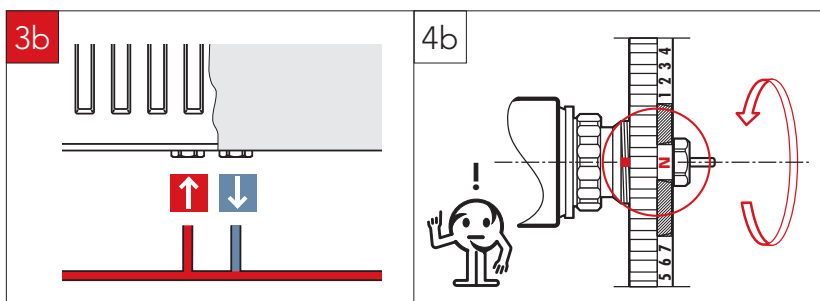

(F) ATTENTION: Pour une parfaite installation des radiateurs, il est primordial que la fixation du radiateur soit effectuée de manière appropriée pour l'utilisation prévue ET toute mauvaise utilisation prévisible. Un certain nombre d'éléments doivent être pris en considération avant de réaliser l'installation comme le type et la qualité de la fixation entre le radiateur et le mur, le type et l'état du mur lui-même ainsi que les charges possibles après le montage.

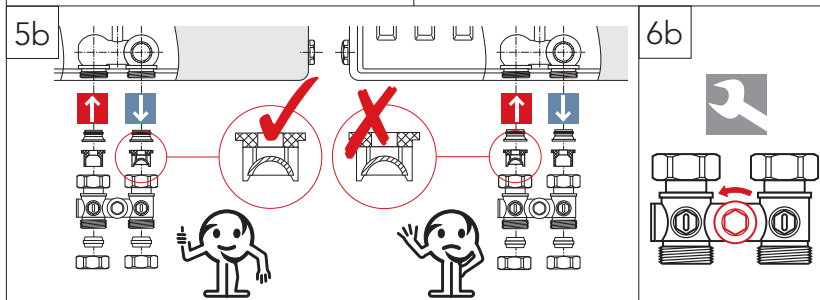

(PL) UWAGA: W celu zapewnienia prawidłowej instalacji grzejników ważne jest wykonanie mocowania grzejnika w sposób, który jest zgodny z przeznaczeniem grzejnika I w sposób zapobiegający jego nieprawidłowemu użytkowaniu. Przed końcową instalacją należy wziąć pod uwagę między innymi metodę mocowania grzejnika do ściany, rodzaj i stan ściany do której będzie mocowany grzejnik oraz wszystkie potencjalne siły i obciążenia.

7b

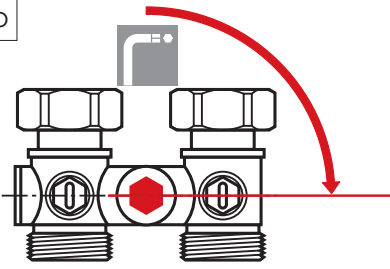

8b

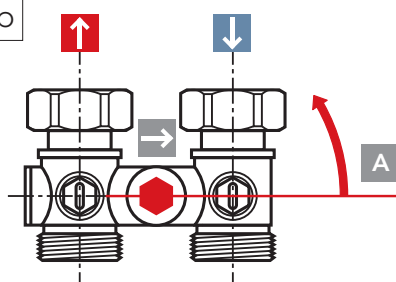

		A
30 %	70 %	3,75 x
35 %	65 %	3,25 x
40 %	60 %	2,5 x
45 %	55 %	2,25 x
50 %	50 %	2,0 x

9

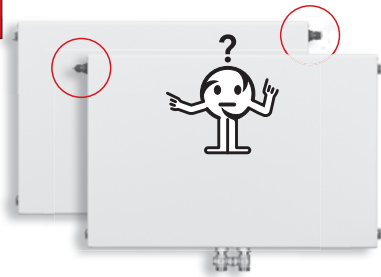

10

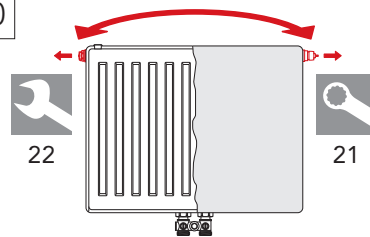

11

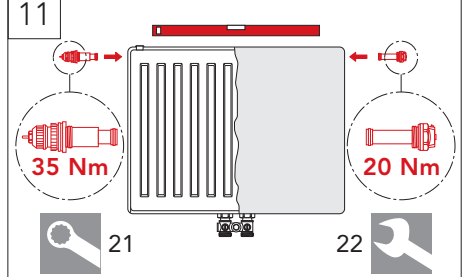

12

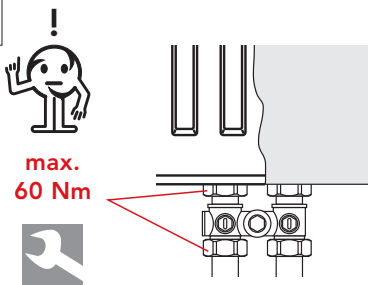

13

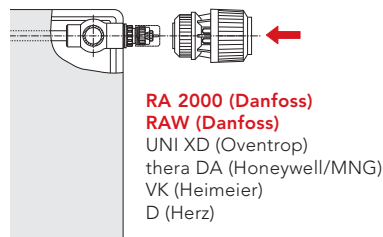

14

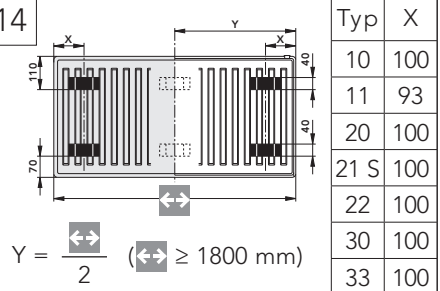

A



B

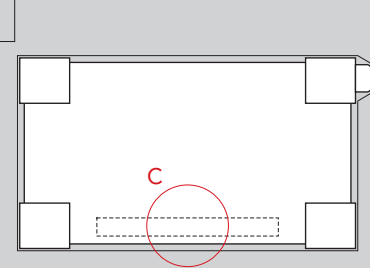

C

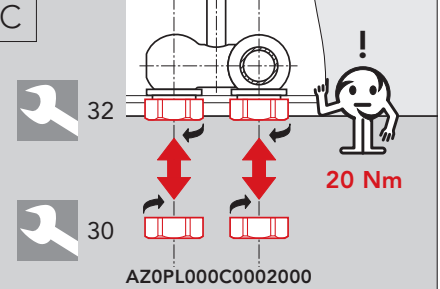

D

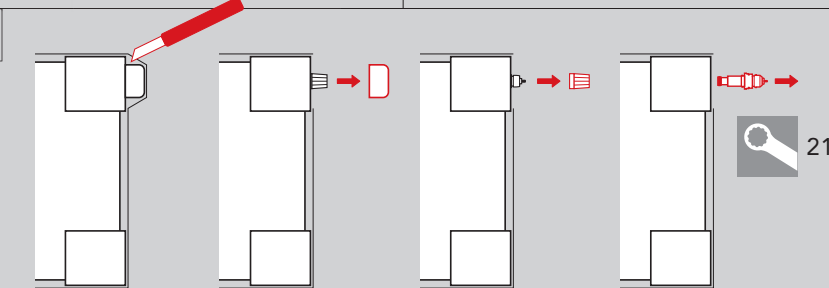

E

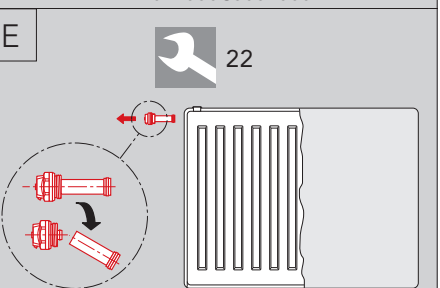

F

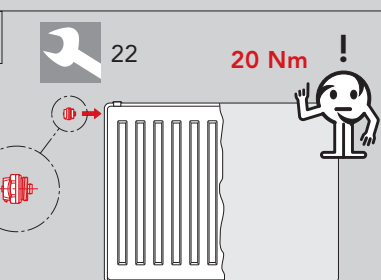

G

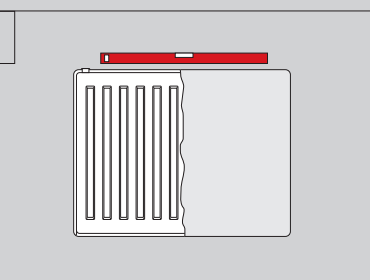

H

