

*„BEIM PLANEN
BENÖTIGE ICH MAXIMALE
FREIHEIT DURCH EIN BREITES
GRÖSSEN- UND FARBANGEBOT –
DAZU KOMPROMISSLOSE QUALITÄT
UND MEHRLEISTUNG!“*



LASERLINE Radiatoren entsprechen allen Anforderungen moderner Heizkultur. Egal ob im klassischen Wohnbereich oder in öffentlichen Räumen. Die große Modellvielfalt kombiniert mit einer großzügigen Farbpalette, bietet jedem Anwender ein höchstes Ausmaß an WärmeKomfort. Der große Strahlungsanteil sowie die kurzen Reaktionszeiten bewirken ein schnelles Aufheizen der Räume. Laserline Radiatoren sind das ideale Wärmetauschersystem für den Betrieb mit Wärmepumpe und/oder Niedertemperatursystemen. Glatte gerundete Oberflächen im Softline Design machen das Reinigen der Heizflächen besonders einfach und sind daher auch für Allergiker geeignet.

LASERLINE
STANDARD



LASERLINE
STANDARD _____ 154

LASERLINE
MITTENANSCHLUSS



LASERLINE VENTIL-
MITTENANSCHLUSS _____ 180

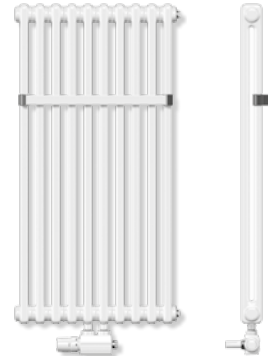

LASERLINE
TWIN _____ 193

LASERLINE
ARCHITECTURE

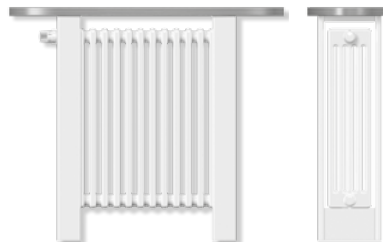

LASERLINE ARCHITECTURE
WÄRME-THEKE _____ 195

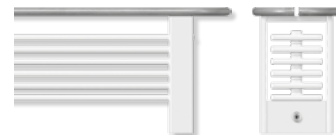

LASERLINE ARCHITECTURE
WÄRME-BANK _____ 197

1

ULOW-E2

Profil-
heizkörper

Plan-
heizkörper

Vertikal-
heizkörper

Zubehör

2

Noppen-
system

Klettsystem

Tacker-
system

Verlegeschie-
nensystem

Gittermatten-
system

Trocken-
system

Zubehör

3

Bad-
heizkörper

Design-
heizkörper

Elektro-
heizkörper

4

LASERLINE RÖHRENRADIATOREN

BASICS

Zubehör _____ 199
Bestellformulare _____ 205



LASERLINE STANDARD

NORM-WÄRMELEISTUNG (WATT) BEI 75/65/20 °C NACH EN 442, DIN REGISTRIERNUMMER 6R0900

Achtung: Die Bauhöhe 155 mm kann nicht mit Radiatorenhalter montiert werden! Die Preise verstehen sich ohne Befestigung.

Bauhöhe [mm] 155		2-Säuler		3-Säuler		4-Säuler		5-Säuler		6-Säuler	
Modell		2016		3016		4016		5016		6016	
Leistung/Glied Watt		12,66		17,51		22,83		28,71		34,80	
Preis/Glied EUR		15,70		16,60		18,86		22,62		26,39	
Wasserin./Glied Liter		0,27		0,39		0,51		0,63		0,75	
Leergewicht/Glied kg		0,30		0,45		0,61		0,76		0,93	
Glieder	Bau- länge [mm]	Watt	EUR	Watt	EUR	Watt	EUR	Watt	EUR	Watt	EUR
4	200	50	62,80	70	66,40	91	75,44	114	90,48	139	105,56
5	250	63	78,50	87	83,00	114	94,30	143	113,10	174	131,95
6	300	75	94,20	105	99,60	136	113,16	172	135,72	208	158,34
7	350	88	109,90	122	116,20	159	132,02	200	158,34	243	184,73
8	400	101	125,60	140	132,80	182	150,88	229	180,96	278	211,12
9	450	113	141,30	157	149,40	205	169,74	258	203,58	313	237,51
10	500	126	157,00	175	166,00	228	188,60	287	226,20	348	263,90
11	550	139	172,70	192	182,60	251	207,46	315	248,82	382	290,29
12	600	151	188,40	210	199,20	273	226,32	344	271,44	417	316,68
13	650	164	204,10	227	215,80	296	245,18	373	294,06	452	343,07
14	700	177	219,80	245	232,40	319	264,04	401	316,68	487	369,46
15	750	189	235,50	262	249,00	342	282,90	430	339,30	522	395,85
16	800	202	251,20	280	265,60	365	301,76	459	361,92	556	422,24
17	850	215	266,90	297	282,20	388	320,62	488	384,54	591	448,63
18	900	227	282,60	315	298,80	410	339,48	516	407,16	626	475,02
19	950	240	298,30	332	315,40	433	358,34	545	429,78	661	501,41
20	1000	253	314,00	350	332,00	456	377,20	574	452,40	696	527,80
21	1050	265	329,70	367	348,60	479	396,06	602	475,02	730	554,19
22	1100	278	345,40	385	365,20	502	414,92	631	497,64	765	580,58
23	1150	291	361,10	402	381,80	525	433,78	660	520,26	800	606,97
24	1200	303	376,80	420	398,40	547	452,64	689	542,88	835	633,36
25	1250	316	392,50	437	415,00	570	471,50	717	565,50	870	659,75
26	1300	329	408,20	455	431,60	593	490,36	746	588,12	904	686,14
27	1350	341	423,90	472	448,20	616	509,22	775	610,74	939	712,53
28	1400	354	439,60	490	464,80	639	528,08	803	633,36	974	738,92
29	1450	367	455,30	507	481,40	662	546,94	832	655,98	1009	765,31
30	1500	379	471,00	525	498,00	684	565,80	861	678,60	1044	791,70
31	1550	392	486,70	542	514,60	707	584,66	890	701,22	1078	818,09
32	1600	405	502,40	560	531,20	730	603,52	918	723,84	1113	844,48
33	1650	417	518,10	577	547,80	753	622,38	947	746,46	1148	870,87
34	1700	430	533,80	595	564,40	776	641,24	976	769,08	1183	897,26
35	1750	443	549,50	612	581,00	799	660,10	1004	791,70	1218	923,65
36	1800	455	565,20	630	597,60	821	678,96	1033	814,32	1252	950,04
37	1850	468	580,90	647	614,20	844	697,82	1062	836,94	1287	976,43
38	1900	481	596,60	665	630,80	867	716,68	1090	859,56	1322	1.002,82
39	1950	493	612,30	682	647,40	890	735,54	1119	882,18	1357	1.029,21
40	2000	506	628,00	700	664,00	913	754,40	1148	904,80	1392	1.055,60
41	2050	519	643,70	717	680,60	936	773,26	1177	927,42	1426	1.081,99
42	2100	531	659,40	735	697,20	958	792,12	1205	950,04	1461	1.108,38
43	2150	544	675,10	752	713,80	981	810,98	1234	972,66	1496	1.134,77
44	2200	557	690,80	770	730,40	1004	829,84	1263	995,28	1531	1.161,16
45	2250	569	706,50	787	747,00	1027	848,70	1291	1.017,90	1566	1.187,55
46	2300	582	722,20	805	763,60	1050	867,56	1320	1.040,52	1600	1.213,94
47	2350	595	737,90	822	780,20	1073	886,42	1349	1.063,14	1635	1.240,33
48	2400	607	753,60	840	796,80	1095	905,28	1378	1.085,76	1670	1.266,72
49	2450	620	769,30	857	813,40	1118	924,14	1406	1.108,38	1705	1.293,11
50	2500	633	785,00	875	830,00	1141	943,00	1435	1.131,00	1740	1.319,50

Grau hinterlegte Preise: Lieferung in einem Block möglich.

Druckfehler, technische und preisliche Änderungen vorbehalten. Unverbindliche Preisempfehlung exkl. MwSt. gültig ab 1.2.2016. Achtung: Für jede Produktgruppe gelten unterschiedliche Rabattsätze.



ULOW-E2

Profil-
heizkörper

Plan-
heizkörper

Vertikal-
heizkörper

Zubehör



Noppen-
system

Klettssystem

Tacker-
system

Verlegeschie-
nensystem

Gittermatten-
system

Trocken-
system

Zubehör



Bad-
heizkörper

Design-
heizkörper

Elektro-
heizkörper



LASERLINE
Standard

NORM-WÄRMELEISTUNG (WATT) BEI 75/65/20 °C NACH EN 442, DIN REGISTRIERNUMMER 6R0900

Die Preise verstehen sich ohne Befestigung.

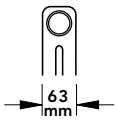
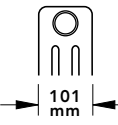
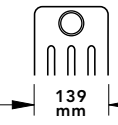
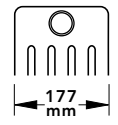
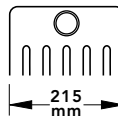
Bauhöhe [mm] 300		2-Säuler		3-Säuler		4-Säuler		5-Säuler		6-Säuler	
Nabenabstand 235 mm											
Modell		2030		3030		4030		5030		6030	
Leistung/Glied Watt		25,24		35,40		45,56		55,98		66,39	
Preis/Glied EUR		15,82		17,12		19,22		22,90		26,75	
Wasserin./Glied Liter		0,40		0,57		0,75		0,93		1,11	
Leergewicht/Glied kg		0,52		0,78		1,05		1,30		1,57	
Glieder	Bau- länge [mm]	Watt	EUR	Watt	EUR	Watt	EUR	Watt	EUR	Watt	EUR
4	200	100	63,28	141	68,48	182	76,88	223	91,60	265	107,00
5	250	126	79,10	177	85,60	227	96,10	279	114,50	331	133,75
6	300	151	94,92	212	102,72	273	115,32	335	137,40	398	160,50
7	350	176	110,74	247	119,84	318	134,54	391	160,30	464	187,25
8	400	201	126,56	283	136,96	364	153,76	447	183,20	531	214,00
9	450	227	142,38	318	154,08	410	172,98	503	206,10	597	240,75
10	500	252	158,20	354	171,20	455	192,20	559	229,00	663	267,50
11	550	277	174,02	389	188,32	501	211,42	615	251,90	730	294,25
12	600	302	189,84	424	205,44	546	230,64	671	274,80	796	321,00
13	650	328	205,66	460	222,56	592	249,86	727	297,70	863	347,75
14	700	353	221,48	495	239,68	637	269,08	783	320,60	929	374,50
15	750	378	237,30	531	256,80	683	288,30	839	343,50	995	401,25
16	800	403	253,12	566	273,92	728	307,52	895	366,40	1062	428,00
17	850	429	268,94	601	291,04	774	326,74	951	389,30	1128	454,75
18	900	454	284,76	637	308,16	820	345,96	1007	412,20	1195	481,50
19	950	479	300,58	672	325,28	865	365,18	1063	435,10	1261	508,25
20	1000	504	316,40	708	342,40	911	384,40	1119	458,00	1327	535,00
21	1050	530	332,22	743	359,52	956	403,62	1175	480,90	1394	561,75
22	1100	555	348,04	778	376,64	1002	422,84	1231	503,80	1460	588,50
23	1150	580	363,86	814	393,76	1047	442,06	1287	526,70	1526	615,25
24	1200	605	379,68	849	410,88	1093	461,28	1343	549,60	1593	642,00
25	1250	631	395,50	885	428,00	1139	480,50	1399	572,50	1659	668,75
26	1300	656	411,32	920	445,12	1184	499,72	1455	595,40	1726	695,50
27	1350	681	427,14	955	462,24	1230	518,94	1511	618,30	1792	722,25
28	1400	706	442,96	991	479,36	1275	538,16	1567	641,20	1858	749,00
29	1450	731	458,78	1026	496,48	1321	557,38	1623	664,10	1925	775,75
30	1500	757	474,60	1062	513,60	1366	576,60	1679	687,00	1991	802,50
31	1550	782	490,42	1097	530,72	1412	595,82	1735	709,90	2058	829,25
32	1600	807	506,24	1132	547,84	1457	615,04	1791	732,80	2124	856,00
33	1650	832	522,06	1168	564,96	1503	634,26	1847	755,70	2190	882,75
34	1700	858	537,88	1203	582,08	1549	653,48	1903	778,60	2257	909,50
35	1750	883	553,70	1239	599,20	1594	672,70	1959	801,50	2323	936,25
36	1800	908	569,52	1274	616,32	1640	691,92	2015	824,40	2390	963,00
37	1850	933	585,34	1309	633,44	1685	711,14	2071	847,30	2456	989,75
38	1900	959	601,16	1345	650,56	1731	730,36	2127	870,20	2522	1.016,50
39	1950	984	616,98	1380	667,68	1776	749,58	2183	893,10	2589	1.043,25
40	2000	1009	632,80	1416	684,80	1822	768,80	2239	916,00	2655	1.070,00
41	2050	1034	648,62	1451	701,92	1867	788,02	2295	938,90	2721	1.096,75
42	2100	1060	664,44	1486	719,04	1913	807,24	2351	961,80	2788	1.123,50
43	2150	1085	680,26	1522	736,16	1959	826,46	2407	984,70	2854	1.150,25
44	2200	1110	696,08	1557	753,28	2004	845,68	2463	1.007,60	2921	1.177,00
45	2250	1135	711,90	1593	770,40	2050	864,90	2519	1.030,50	2987	1.203,75
46	2300	1161	727,72	1628	787,52	2095	884,12	2575	1.053,40	3053	1.230,50
47	2350	1186	743,54	1663	804,64	2141	903,34	2631	1.076,30	3120	1.257,25
48	2400	1211	759,36	1699	821,76	2186	922,56	2687	1.099,20	3186	1.284,00
49	2450	1236	775,18	1734	838,88	2232	941,78	2743	1.122,10	3253	1.310,75
50	2500	1262	791,00	1770	856,00	2278	961,00	2799	1.145,00	3319	1.337,50

Druckfehler, technische und preisliche Änderungen vorbehalten. Unverbindliche Preisempfehlung exkl. MwSt. gültig ab 1.2.2016.
Achtung: Für jede Produktgruppe gelten unterschiedliche Rabattsätze.

Grau hinterlegte Preise: Lieferung in einem Block möglich.

NORM-WÄRMELEISTUNG (WATT) BEI 75/65/20 °C NACH EN 442, DIN REGISTRIERNUMMER 6R0900

Die Preise verstehen sich ohne Befestigung.

Bauhöhe [mm] 350		2-Säuler		3-Säuler		4-Säuler		5-Säuler		6-Säuler	
Nabenabstand 285 mm											
Modell		2035		3035		4035		5035		6035	
Leistung/Glied Watt		28,96		40,50		52,04		63,99		75,93	
Preis/Glied EUR		16,20		17,64		19,82		23,53		27,58	
Wasserin./Glied Liter		0,44		0,64		0,84		1,03		1,23	
Leergewicht/Glied kg		0,60		0,89		1,20		1,49		1,86	
Glieder	Bau- länge [mm]	Watt	EUR	Watt	EUR	Watt	EUR	Watt	EUR	Watt	EUR
4	200	115	64,80	162	70,56	208	79,28	255	94,12	303	110,32
5	250	144	81,00	202	88,20	260	99,10	319	117,65	379	137,90
6	300	173	97,20	243	105,84	312	118,92	383	141,18	455	165,48
7	350	202	113,40	283	123,48	364	138,74	447	164,71	531	193,06
8	400	231	129,60	324	141,12	416	158,56	511	188,24	607	220,64
9	450	260	145,80	364	158,76	468	178,38	575	211,77	683	248,22
10	500	289	162,00	405	176,40	520	198,20	639	235,30	759	275,80
11	550	318	178,20	445	194,04	572	218,02	703	258,83	835	303,38
12	600	347	194,40	486	211,68	624	237,84	767	282,36	911	330,96
13	650	376	210,60	526	229,32	676	257,66	831	305,89	987	358,54
14	700	405	226,80	567	246,96	728	277,48	895	329,42	1063	386,12
15	750	434	243,00	607	264,60	780	297,30	959	352,95	1138	413,70
16	800	463	259,20	648	282,24	832	317,12	1023	376,48	1214	441,28
17	850	492	275,40	688	299,88	884	336,94	1087	400,01	1290	468,86
18	900	521	291,60	729	317,52	936	356,76	1151	423,54	1366	496,44
19	950	550	307,80	769	335,16	988	376,58	1215	447,07	1442	524,02
20	1000	579	324,00	810	352,80	1040	396,40	1279	470,60	1518	551,60
21	1050	608	340,20	850	370,44	1092	416,22	1343	494,13	1594	579,18
22	1100	637	356,40	891	388,08	1144	436,04	1407	517,66	1670	606,76
23	1150	666	372,60	931	405,72	1196	455,86	1471	541,19	1746	634,34
24	1200	695	388,80	972	423,36	1248	475,68	1535	564,72	1822	661,92
25	1250	724	405,00	1012	441,00	1301	495,50	1599	588,25	1898	689,50
26	1300	752	421,20	1053	458,64	1353	515,32	1663	611,78	1974	717,08
27	1350	781	437,40	1093	476,28	1405	535,14	1727	635,31	2050	744,66
28	1400	810	453,60	1134	493,92	1457	554,96	1791	658,84	2126	772,24
29	1450	839	469,80	1174	511,56	1509	574,78	1855	682,37	2201	799,82
30	1500	868	486,00	1215	529,20	1561	594,60	1919	705,90	2277	827,40
31	1550	897	502,20	1255	546,84	1613	614,42	1983	729,43	2353	854,98
32	1600	926	518,40	1296	564,48	1665	634,24	2047	752,96	2429	882,56
33	1650	955	534,60	1336	582,12	1717	654,06	2111	776,49	2505	910,14
34	1700	984	550,80	1377	599,76	1769	673,88	2175	800,02	2581	937,72
35	1750	1013	567,00	1417	617,40	1821	693,70	2239	823,55	2657	965,30
36	1800	1042	583,20	1458	635,04	1873	713,52	2303	847,08	2733	992,88
37	1850	1071	599,40	1498	652,68	1925	733,34	2367	870,61	2809	1.020,46
38	1900	1100	615,60	1539	670,32	1977	753,16	2431	894,14	2885	1.048,04
39	1950	1129	631,80	1579	687,96	2029	772,98	2495	917,67	2961	1.075,62
40	2000	1158	648,00	1620	705,60	2081	792,80	2559	941,20	3037	1.103,20
41	2050	1187	664,20	1660	723,24	2133	812,62	2623	964,73	3113	1.130,78
42	2100	1216	680,40	1701	740,88	2185	832,44	2687	988,26	3189	1.158,36
43	2150	1245	696,60	1741	758,52	2237	852,26	2751	1.011,79	3264	1.185,94
44	2200	1274	712,80	1782	776,16	2289	872,08	2815	1.035,32	3340	1.213,52
45	2250	1303	729,00	1822	793,80	2341	891,90	2879	1.058,85	3416	1.241,10
46	2300	1332	745,20	1863	811,44	2393	911,72	2943	1.082,38	3492	1.268,68
47	2350	1361	761,40	1903	829,08	2445	931,54	3007	1.105,91	3568	1.296,26
48	2400	1390	777,60	1944	846,72	2497	951,36	3071	1.129,44	3644	1.323,84
49	2450	1419	793,80	1984	864,36	2549	971,18	3135	1.152,97	3720	1.351,42
50	2500	1448	810,00	2025	882,00	2602	991,00	3199	1.176,50	3796	1.379,00

LASERLINE
Standard

Grau hinterlegte Preise: Lieferung in einem Block möglich.

Druckfehler, technische und preisliche Änderungen vorbehalten. Unverbindliche Preisempfehlung exkl. MwSt. gültig ab 1.2.2016.
Achtung: Für jede Produktgruppe gelten unterschiedliche Rabattsätze.

NORM-WÄRMELEISTUNG (WATT) BEI 75/65/20 °C NACH EN 442, DIN REGISTRIERNUMMER 6R0900

Die Preise verstehen sich ohne Befestigung.

Bauhöhe [mm] 365				3-Säuler		4-Säuler		5-Säuler		6-Säuler	
Modell				3037		4037		5037		6037	
Leistung/Glied Watt				42,01		53,96		66,36		78,76	
Preis/Glied EUR				17,79		19,99		23,75		27,90	
Wasserin./Glied Liter				0,66		0,86		1,06		1,27	
Leergewicht/Glied kg				0,91		1,22		1,54		1,86	
Glieder	Bau- länge [mm]	Watt	EUR	Watt	EUR	Watt	EUR	Watt	EUR	Watt	EUR
4	200			168	71,16	215	79,96	265	95,00	315	111,60
5	250			210	88,95	269	99,95	331	118,75	393	139,50
6	300			252	106,74	323	119,94	398	142,50	472	167,40
7	350			294	124,53	377	139,93	464	166,25	551	195,30
8	400			336	142,32	431	159,92	530	190,00	630	223,20
9	450			378	160,11	485	179,91	597	213,75	708	251,10
10	500			420	177,90	539	199,90	663	237,50	787	279,00
11	550			462	195,69	593	219,89	729	261,25	866	306,90
12	600			504	213,48	647	239,88	796	285,00	945	334,80
13	650			546	231,27	701	259,87	862	308,75	1023	362,70
14	700			588	249,06	755	279,86	929	332,50	1102	390,60
15	750			630	266,85	809	299,85	995	356,25	1181	418,50
16	800			672	284,64	863	319,84	1061	380,00	1260	446,40
17	850			714	302,43	917	339,83	1128	403,75	1338	474,30
18	900			756	320,22	971	359,82	1194	427,50	1417	502,20
19	950			798	338,01	1025	379,81	1260	451,25	1496	530,10
20	1000			840	355,80	1079	399,80	1327	475,00	1575	558,00
21	1050			882	373,59	1133	419,79	1393	498,75	1653	585,90
22	1100			924	391,38	1187	439,78	1459	522,50	1732	613,80
23	1150			966	409,17	1241	459,77	1526	546,25	1811	641,70
24	1200			1008	426,96	1295	479,76	1592	570,00	1890	669,60
25	1250			1050	444,75	1349	499,75	1659	593,75	1969	697,50
26	1300			1092	462,54	1402	519,74	1725	617,50	2047	725,40
27	1350			1134	480,33	1456	539,73	1791	641,25	2126	753,30
28	1400			1176	498,12	1510	559,72	1858	665,00	2205	781,20
29	1450			1218	515,91	1564	579,71	1924	688,75	2284	809,10
30	1500			1260	533,70	1618	599,70	1990	712,50	2362	837,00
31	1550			1302	551,49	1672	619,69	2057	736,25	2441	864,90
32	1600			1344	569,28	1726	639,68	2123	760,00	2520	892,80
33	1650			1386	587,07	1780	659,67	2189	783,75	2599	920,70
34	1700			1428	604,86	1834	679,66	2256	807,50	2677	948,60
35	1750			1470	622,65	1888	699,65	2322	831,25	2756	976,50
36	1800			1512	640,44	1942	719,64	2388	855,00	2835	1.004,40
37	1850			1554	658,23	1996	739,63	2455	878,75	2914	1.032,30
38	1900			1596	676,02	2050	759,62	2521	902,50	2992	1.060,20
39	1950			1638	693,81	2104	779,61	2588	926,25	3071	1.088,10
40	2000			1680	711,60	2158	799,60	2654	950,00	3150	1.116,00
41	2050			1722	729,39	2212	819,59	2720	973,75	3229	1.143,90
42	2100			1764	747,18	2266	839,58	2787	997,50	3307	1.171,80
43	2150			1806	764,97	2320	859,57	2853	1.021,25	3386	1.199,70
44	2200			1848	782,76	2374	879,56	2919	1.045,00	3465	1.227,60
45	2250			1890	800,55	2428	899,55	2986	1.068,75	3544	1.255,50
46	2300			1932	818,34	2482	919,54	3052	1.092,50	3622	1.283,40
47	2350			1974	836,13	2536	939,53	3118	1.116,25	3701	1.311,30
48	2400			2016	853,92	2590	959,52	3185	1.140,00	3780	1.339,20
49	2450			2058	871,71	2644	979,51	3251	1.163,75	3859	1.367,10
50	2500			2100	889,50	2698	999,50	3318	1.187,50	3938	1.395,00

Druckfehler, technische und preisliche Änderungen vorbehalten. Unverbindliche Preisempfehlung exkl. MwSt. gültig ab 1.2.2016. Achtung: Für jede Produktgruppe gelten unterschiedliche Rabattsätze.

Grau hinterlegte Preise: Lieferung in einem Block möglich.

NORM-WÄRMELEISTUNG (WATT) BEI 75/65/20 °C NACH EN 442, DIN REGISTRIERNUMMER 6R0900

Die Preise verstehen sich ohne Befestigung

Bauhöhe [mm] 400		2-Säuler		3-Säuler		4-Säuler		5-Säuler		6-Säuler	
Nabenabstand 335 mm											
Modell		2040		3040		4040		5040		6040	
Leistung/Glied Watt		32,63		45,52		58,40		71,87		85,33	
Preis/Glied EUR		16,43		18,08		20,28		23,98		28,48	
Wasserin./Glied Liter		0,49		0,70		0,92		1,14		1,35	
Leergewicht/Glied kg		0,68		1,00		1,35		1,67		2,02	
Glieder	Bau- länge [mm]	Watt	EUR	Watt	EUR	Watt	EUR	Watt	EUR	Watt	EUR
4	200	130	65,72	182	72,32	233	81,12	287	95,92	341	113,92
5	250	163	82,15	227	90,40	292	101,40	359	119,90	426	142,40
6	300	195	98,58	273	108,48	350	121,68	431	143,88	511	170,88
7	350	228	115,01	318	126,56	408	141,96	503	167,86	597	199,36
8	400	261	131,44	364	144,64	467	162,24	574	191,84	682	227,84
9	450	293	147,87	409	162,72	525	182,52	646	215,82	767	256,32
10	500	326	164,30	455	180,80	584	202,80	718	239,80	853	284,80
11	550	358	180,73	500	198,88	642	223,08	790	263,78	938	313,28
12	600	391	197,16	546	216,96	700	243,36	862	287,76	1023	341,76
13	650	424	213,59	591	235,04	759	263,64	934	311,74	1109	370,24
14	700	456	230,02	637	253,12	817	283,92	1006	335,72	1194	398,72
15	750	489	246,45	682	271,20	876	304,20	1078	359,70	1279	427,20
16	800	522	262,88	728	289,28	934	324,48	1149	383,68	1365	455,68
17	850	554	279,31	773	307,36	992	344,76	1221	407,66	1450	484,16
18	900	587	295,74	819	325,44	1051	365,04	1293	431,64	1535	512,64
19	950	619	312,17	864	343,52	1109	385,32	1365	455,62	1621	541,12
20	1000	652	328,60	910	361,60	1168	405,60	1437	479,60	1706	569,60
21	1050	685	345,03	955	379,68	1226	425,88	1509	503,58	1791	598,08
22	1100	717	361,46	1001	397,76	1284	446,16	1581	527,56	1877	626,56
23	1150	750	377,89	1046	415,84	1343	466,44	1653	551,54	1962	655,04
24	1200	783	394,32	1092	433,92	1401	486,72	1724	575,52	2047	683,52
25	1250	815	410,75	1138	452,00	1460	507,00	1796	599,50	2133	712,00
26	1300	848	427,18	1183	470,08	1518	527,28	1868	623,48	2218	740,48
27	1350	881	443,61	1229	488,16	1576	547,56	1940	647,46	2303	768,96
28	1400	913	460,04	1274	506,24	1635	567,84	2012	671,44	2389	797,44
29	1450	946	476,47	1320	524,32	1693	588,12	2084	695,42	2474	825,92
30	1500	978	492,90	1365	542,40	1752	608,40	2156	719,40	2559	854,40
31	1550	1011	509,33	1411	560,48	1810	628,68	2227	743,38	2645	882,88
32	1600	1044	525,76	1456	578,56	1868	648,96	2299	767,36	2730	911,36
33	1650	1076	542,19	1502	596,64	1927	669,24	2371	791,34	2815	939,84
34	1700	1109	558,62	1547	614,72	1985	689,52	2443	815,32	2901	968,32
35	1750	1142	575,05	1593	632,80	2044	709,80	2515	839,30	2986	996,80
36	1800	1174	591,48	1638	650,88	2102	730,08	2587	863,28	3071	1.025,28
37	1850	1207	607,91	1684	668,96	2160	750,36	2659	887,26	3157	1.053,76
38	1900	1239	624,34	1729	687,04	2219	770,64	2731	911,24	3242	1.082,24
39	1950	1272	640,77	1775	705,12	2277	790,92	2802	935,22	3327	1.110,72
40	2000	1305	657,20	1820	723,20	2336	811,20	2874	959,20	3413	1.139,20
41	2050	1337	673,63	1866	741,28	2394	831,48	2946	983,18	3498	1.167,68
42	2100	1370	690,06	1911	759,36	2452	851,76	3018	1.007,16	3583	1.196,16
43	2150	1403	706,49	1957	777,44	2511	872,04	3090	1.031,14	3669	1.224,64
44	2200	1435	722,92	2002	795,52	2569	892,32	3162	1.055,12	3754	1.253,12
45	2250	1468	739,35	2048	813,60	2628	912,60	3234	1.079,10	3839	1.281,60
46	2300	1500	755,78	2093	831,68	2686	932,88	3306	1.103,08	3925	1.310,08
47	2350	1533	772,21	2139	849,76	2744	953,16	3377	1.127,06	4010	1.338,56
48	2400	1566	788,64	2184	867,84	2803	973,44	3449	1.151,04	4095	1.367,04
49	2450	1598	805,07	2230	885,92	2861	993,72	3521	1.175,02	4181	1.395,52
50	2500	1631	821,50	2276	904,00	2920	1.014,00	3593	1.199,00	4266	1.424,00

LASERLINE
Standard

Grau hinterlegte Preise: Lieferung in einem Block möglich.

Druckfehler, technische und preisliche Änderungen vorbehalten. Unverbindliche Preisempfehlung exkl. MwSt. gültig ab 1.2.2016.
Achtung: Für jede Produktgruppe gelten unterschiedliche Rabattsätze.

NORM-WÄRMELEISTUNG (WATT) BEI 75/65/20 °C NACH EN 442, DIN REGISTRIERNUMMER 6R0900

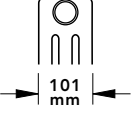
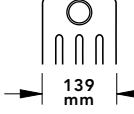
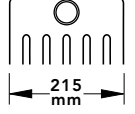
Die Preise verstehen sich ohne Befestigung.											
Bauhöhe [mm] 415				3-Säuler 		4-Säuler 				6-Säuler 	
Nabenabstand 350 mm											
Modell				3042		4042				6042	
Leistung/Glied Watt				47,01		60,29				88,12	
Preis/Glied EUR				18,40		20,87				28,66	
Wasserin./Glied Liter				0,72		0,95				1,39	
Leergewicht/Glied kg				1,03		1,37				2,08	
Glieder	Bau- länge [mm]	Watt	EUR	Watt	EUR	Watt	EUR	Watt	EUR	Watt	EUR
4	200			188	73,60	241	83,48			352	114,64
5	250			235	92,00	301	104,35			440	143,30
6	300			282	110,40	361	125,22			528	171,96
7	350			329	128,80	422	146,09			616	200,62
8	400			376	147,20	482	166,96			704	229,28
9	450			423	165,60	542	187,83			793	257,94
10	500			470	184,00	602	208,70			881	286,60
11	550			517	202,40	663	229,57			969	315,26
12	600			564	220,80	723	250,44			1057	343,92
13	650			611	239,20	783	271,31			1145	372,58
14	700			658	257,60	844	292,18			1233	401,24
15	750			705	276,00	904	313,05			1321	429,90
16	800			752	294,40	964	333,92			1409	458,56
17	850			799	312,80	1024	354,79			1498	487,22
18	900			846	331,20	1085	375,66			1586	515,88
19	950			893	349,60	1145	396,53			1674	544,54
20	1000			940	368,00	1205	417,40			1762	573,20
21	1050			987	386,40	1266	438,27			1850	601,86
22	1100			1034	404,80	1326	459,14			1938	630,52
23	1150			1081	423,20	1386	480,01			2026	659,18
24	1200			1128	441,60	1446	500,88			2114	687,84
25	1250			1175	460,00	1507	521,75			2203	716,50
26	1300			1222	478,40	1567	542,62			2291	745,16
27	1350			1269	496,80	1627	563,49			2379	773,82
28	1400			1316	515,20	1688	584,36			2467	802,48
29	1450			1363	533,60	1748	605,23			2555	831,14
30	1500			1410	552,00	1808	626,10			2643	859,80
31	1550			1457	570,40	1868	646,97			2731	888,46
32	1600			1504	588,80	1929	667,84			2819	917,12
33	1650			1551	607,20	1989	688,71			2907	945,78
34	1700			1598	625,60	2049	709,58			2996	974,44
35	1750			1645	644,00	2110	730,45			3084	1.003,10
36	1800			1692	662,40	2170	751,32			3172	1.031,76
37	1850			1739	680,80	2230	772,19			3260	1.060,42
38	1900			1786	699,20	2291	793,06			3348	1.089,08
39	1950			1833	717,60	2351	813,93			3436	1.117,74
40	2000			1880	736,00	2411	834,80			3524	1.146,40
41	2050			1927	754,40	2471	855,67			3612	1.175,06
42	2100			1974	772,80	2532	876,54			3701	1.203,72
43	2150			2021	791,20	2592	897,41			3789	1.232,38
44	2200			2068	809,60	2652	918,28			3877	1.261,04
45	2250			2115	828,00	2713	939,15			3965	1.289,70
46	2300			2162	846,40	2773	960,02			4053	1.318,36
47	2350			2209	864,80	2833	980,89			4141	1.347,02
48	2400			2256	883,20	2893	1.001,76			4229	1.375,68
49	2450			2303	901,60	2954	1.022,63			4317	1.404,34
50	2500			2350	920,00	3014	1.043,50			4406	1.433,00

NORM-WÄRMELEISTUNG (WATT) BEI 75/65/20 °C NACH EN 442, DIN REGISTRIERNUMMER 6R0900

Die Preise verstehen sich ohne Befestigung.

Bauhöhe [mm] 450		2-Säuler		3-Säuler		4-Säuler		5-Säuler		6-Säuler	
Nababstand 385 mm											
Modell		2045		3045		4045		5045		6045	
Leistung/Glied Watt		36,26		50,47		64,68		79,64		94,60	
Preis/Glied EUR		16,88		19,01		21,10		24,97		28,89	
Wasserin./Glied Liter		0,53		0,76		1,01		1,24		1,48	
Leergewicht/Glied kg		0,75		1,12		1,49		1,86		2,24	
Glieder	Bau- länge [mm]	Watt	EUR	Watt	EUR	Watt	EUR	Watt	EUR	Watt	EUR
4	200	145	67,52	201	76,04	258	84,40	318	99,88	378	115,56
5	250	181	84,40	252	95,05	323	105,50	398	124,85	473	144,45
6	300	217	101,28	302	114,06	388	126,60	477	149,82	567	173,34
7	350	253	118,16	353	133,07	452	147,70	557	174,79	662	202,23
8	400	290	135,04	403	152,08	517	168,80	637	199,76	756	231,12
9	450	326	151,92	454	171,09	582	189,90	716	224,73	851	260,01
10	500	362	168,80	504	190,10	646	211,00	796	249,70	946	288,90
11	550	398	185,68	555	209,11	711	232,10	876	274,67	1040	317,79
12	600	435	202,56	605	228,12	776	253,20	955	299,64	1135	346,68
13	650	471	219,44	656	247,13	840	274,30	1035	324,61	1229	375,57
14	700	507	236,32	706	266,14	905	295,40	1114	349,58	1324	404,46
15	750	543	253,20	757	285,15	970	316,50	1194	374,55	1419	433,35
16	800	580	270,08	807	304,16	1034	337,60	1274	399,52	1513	462,24
17	850	616	286,96	857	323,17	1099	358,70	1353	424,49	1608	491,13
18	900	652	303,84	908	342,18	1164	379,80	1433	449,46	1702	520,02
19	950	688	320,72	958	361,19	1228	400,90	1513	474,43	1797	548,91
20	1000	725	337,60	1009	380,20	1293	422,00	1592	499,40	1892	577,80
21	1050	761	354,48	1059	399,21	1358	443,10	1672	524,37	1986	606,69
22	1100	797	371,36	1110	418,22	1422	464,20	1752	549,34	2081	635,58
23	1150	833	388,24	1160	437,23	1487	485,30	1831	574,31	2175	664,47
24	1200	870	405,12	1211	456,24	1552	506,40	1911	599,28	2270	693,36
25	1250	906	422,00	1261	475,25	1617	527,50	1991	624,25	2365	722,25
26	1300	942	438,88	1312	494,26	1681	548,60	2070	649,22	2459	751,14
27	1350	979	455,76	1362	513,27	1746	569,70	2150	674,19	2554	780,03
28	1400	1015	472,64	1413	532,28	1811	590,80	2229	699,16	2648	808,92
29	1450	1051	489,52	1463	551,29	1875	611,90	2309	724,13	2743	837,81
30	1500	1087	506,40	1514	570,30	1940	633,00	2389	749,10	2838	866,70
31	1550	1124	523,28	1564	589,31	2005	654,10	2468	774,07	2932	895,59
32	1600	1160	540,16	1615	608,32	2069	675,20	2548	799,04	3027	924,48
33	1650	1196	557,04	1665	627,33	2134	696,30	2628	824,01	3121	953,37
34	1700	1232	573,92	1715	646,34	2199	717,40	2707	848,98	3216	982,26
35	1750	1269	590,80	1766	665,35	2263	738,50	2787	873,95	3311	1.011,15
36	1800	1305	607,68	1816	684,36	2328	759,60	2867	898,92	3405	1.040,04
37	1850	1341	624,56	1867	703,37	2393	780,70	2946	923,89	3500	1.068,93
38	1900	1377	641,44	1917	722,38	2457	801,80	3026	948,86	3594	1.097,82
39	1950	1414	658,32	1968	741,39	2522	822,90	3105	973,83	3689	1.126,71
40	2000	1450	675,20	2018	760,40	2587	844,00	3185	998,80	3784	1.155,60
41	2050	1486	692,08	2069	779,41	2651	865,10	3265	1.023,77	3878	1.184,49
42	2100	1522	708,96	2119	798,42	2716	886,20	3344	1.048,74	3973	1.213,38
43	2150	1559	725,84	2170	817,43	2781	907,30	3424	1.073,71	4067	1.242,27
44	2200	1595	742,72	2220	836,44	2845	928,40	3504	1.098,68	4162	1.271,16
45	2250	1631	759,60	2271	855,45	2910	949,50	3583	1.123,65	4257	1.300,05
46	2300	1667	776,48	2321	874,46	2975	970,60	3663	1.148,62	4351	1.328,94
47	2350	1704	793,36	2372	893,47	3039	991,70	3743	1.173,59	4446	1.357,83
48	2400	1740	810,24	2422	912,48	3104	1.012,80	3822	1.198,56	4540	1.386,72
49	2450	1776	827,12	2473	931,49	3169	1.033,90	3902	1.223,53	4635	1.415,61
50	2500	1813	844,00	2523	950,50	3234	1.055,00	3982	1.248,50	4730	1.444,50

LASERLINE
Standard

Grau hinterlegte Preise: Lieferung in einem Block möglich.

Druckfehler, technische und preisliche Änderungen vorbehalten. Unverbindliche Preisempfehlung exkl. MwSt. gültig ab 1.2.2016.
Achtung: Für jede Produktgruppe gelten unterschiedliche Rabattsätze.

NORM-WÄRMELEISTUNG (WATT) BEI 75/65/20 °C NACH EN 442, DIN REGISTRIERNUMMER 6R0900

Die Preise verstehen sich ohne Befestigung.

Bauhöhe [mm] 500		2-Säuler		3-Säuler		4-Säuler		5-Säuler		6-Säuler	
Nabenabstand 435 mm		63 mm		101 mm		139 mm		177 mm		215 mm	
Modell		2050		3050		4050		5050		6050	
Leistung/Glied Watt		39,87		55,38		70,88		87,32		103,76	
Preis/Glied EUR		17,28		19,66		21,79		25,41		29,86	
Wasserin./Glied Liter		0,57		0,83		1,09		1,34		1,60	
Leergewicht/Glied kg		0,83		1,23		1,64		2,04		2,46	
Glieder	Bau- länge [mm]	Watt	EUR	Watt	EUR	Watt	EUR	Watt	EUR	Watt	EUR
4	200	159	69,12	221	78,64	283	87,16	349	101,64	415	119,44
5	250	199	86,40	276	98,30	354	108,95	436	127,05	518	149,30
6	300	239	103,68	332	117,96	425	130,74	523	152,46	622	179,16
7	350	279	120,96	387	137,62	496	152,53	611	177,87	726	209,02
8	400	318	138,24	443	157,28	567	174,32	698	203,28	830	238,88
9	450	358	155,52	498	176,94	637	196,11	785	228,69	933	268,74
10	500	398	172,80	553	196,60	708	217,90	873	254,10	1037	298,60
11	550	438	190,08	609	216,26	779	239,69	960	279,51	1141	328,46
12	600	478	207,36	664	235,92	850	261,48	1047	304,92	1245	358,32
13	650	518	224,64	719	255,58	921	283,27	1135	330,33	1348	388,18
14	700	558	241,92	775	275,24	992	305,06	1222	355,74	1452	418,04
15	750	598	259,20	830	294,90	1063	326,85	1309	381,15	1556	447,90
16	800	637	276,48	886	314,56	1134	348,64	1397	406,56	1660	477,76
17	850	677	293,76	941	334,22	1204	370,43	1484	431,97	1763	507,62
18	900	717	311,04	996	353,88	1275	392,22	1571	457,38	1867	537,48
19	950	757	328,32	1052	373,54	1346	414,01	1659	482,79	1971	567,34
20	1000	797	345,60	1107	393,20	1417	435,80	1746	508,20	2075	597,20
21	1050	837	362,88	1162	412,86	1488	457,59	1833	533,61	2178	627,06
22	1100	877	380,16	1218	432,52	1559	479,38	1921	559,02	2282	656,92
23	1150	917	397,44	1273	452,18	1630	501,17	2008	584,43	2386	686,78
24	1200	956	414,72	1329	471,84	1701	522,96	2095	609,84	2490	716,64
25	1250	996	432,00	1384	491,50	1772	544,75	2183	635,25	2594	746,50
26	1300	1036	449,28	1439	511,16	1842	566,54	2270	660,66	2697	776,36
27	1350	1076	466,56	1495	530,82	1913	588,33	2357	686,07	2801	806,22
28	1400	1116	483,84	1550	550,48	1984	610,12	2444	711,48	2905	836,08
29	1450	1156	501,12	1606	570,14	2055	631,91	2532	736,89	3009	865,94
30	1500	1196	518,40	1661	589,80	2126	653,70	2619	762,30	3112	895,80
31	1550	1235	535,68	1716	609,46	2197	675,49	2706	787,71	3216	925,66
32	1600	1275	552,96	1772	629,12	2268	697,28	2794	813,12	3320	955,52
33	1650	1315	570,24	1827	648,78	2339	719,07	2881	838,53	3424	985,38
34	1700	1355	587,52	1882	668,44	2409	740,86	2968	863,94	3527	1.015,24
35	1750	1395	604,80	1938	688,10	2480	762,65	3056	889,35	3631	1.045,10
36	1800	1435	622,08	1993	707,76	2551	784,44	3143	914,76	3735	1.074,96
37	1850	1475	639,36	2049	727,42	2622	806,23	3230	940,17	3839	1.104,82
38	1900	1515	656,64	2104	747,08	2693	828,02	3318	965,58	3942	1.134,68
39	1950	1554	673,92	2159	766,74	2764	849,81	3405	990,99	4046	1.164,54
40	2000	1594	691,20	2215	786,40	2835	871,60	3492	1.016,40	4150	1.194,40
41	2050	1634	708,48	2270	806,06	2906	893,39	3580	1.041,81	4254	1.224,26
42	2100	1674	725,76	2325	825,72	2976	915,18	3667	1.067,22	4357	1.254,12
43	2150	1714	743,04	2381	845,38	3047	936,97	3754	1.092,63	4461	1.283,98
44	2200	1754	760,32	2436	865,04	3118	958,76	3842	1.118,04	4565	1.313,84
45	2250	1794	777,60	2492	884,70	3189	980,55	3929	1.143,45	4669	1.343,70
46	2300	1834	794,88	2547	904,36	3260	1.002,34	4016	1.168,86	4772	1.373,56
47	2350	1873	812,16	2602	924,02	3331	1.024,13	4104	1.194,27	4876	1.403,42
48	2400	1913	829,44	2658	943,68	3402	1.045,92	4191	1.219,68	4980	1.433,28
49	2450	1953	846,72	2713	963,34	3473	1.067,71	4278	1.245,09	5084	1.463,14
50	2500	1993	864,00	2769	983,00	3544	1.089,50	4366	1.270,50	5188	1.493,00

Druckfehler, technische und preisliche Änderungen vorbehalten. Unverbindliche Preisempfehlung exkl. MwSt. gültig ab 1.2.2016.
Achtung: Für jede Produktgruppe gelten unterschiedliche Rabattsätze.

Grau hinterlegte Preise: Lieferung in einem Block möglich.

NORM-WÄRMELEISTUNG (WATT) BEI 75/65/20 °C NACH EN 442, DIN REGISTRIERNUMMER 6R0900

Die Preise verstehen sich ohne Befestigung.

Bauhöhe [mm] 550		2-Säuler		3-Säuler		4-Säuler		5-Säuler		6-Säuler	
Nabenabstand 485 mm											
Modell		2055		3055		4055		5055		6055	
Leistung/Glied Watt		43,46		60,25		77,03		94,93		112,83	
Preis/Glied EUR		17,72		20,04		22,54		26,47		31,14	
Wasserin./Glied Liter		0,62		0,89		1,17		1,45		1,73	
Leergewicht/Glied kg		0,91		1,34		1,79		2,23		2,68	
Glieder	Bau- länge [mm]	Watt	EUR	Watt	EUR	Watt	EUR	Watt	EUR	Watt	EUR
4	200	173	70,88	241	80,16	308	90,16	379	105,88	451	124,56
5	250	217	88,60	301	100,20	385	112,70	474	132,35	564	155,70
6	300	260	106,32	361	120,24	462	135,24	569	158,82	676	186,84
7	350	304	124,04	421	140,28	539	157,78	664	185,29	789	217,98
8	400	347	141,76	482	160,32	616	180,32	759	211,76	902	249,12
9	450	391	159,48	542	180,36	693	202,86	854	238,23	1015	280,26
10	500	434	177,20	602	200,40	770	225,40	949	264,70	1128	311,40
11	550	478	194,92	662	220,44	847	247,94	1044	291,17	1241	342,54
12	600	521	212,64	723	240,48	924	270,48	1139	317,64	1353	373,68
13	650	564	230,36	783	260,52	1001	293,02	1234	344,11	1466	404,82
14	700	608	248,08	843	280,56	1078	315,56	1329	370,58	1579	435,96
15	750	651	265,80	903	300,60	1155	338,10	1423	397,05	1692	467,10
16	800	695	283,52	964	320,64	1232	360,64	1518	423,52	1805	498,24
17	850	738	301,24	1024	340,68	1309	383,18	1613	449,99	1918	529,38
18	900	782	318,96	1084	360,72	1386	405,72	1708	476,46	2030	560,52
19	950	825	336,68	1144	380,76	1463	428,26	1803	502,93	2143	591,66
20	1000	869	354,40	1205	400,80	1540	450,80	1898	529,40	2256	622,80
21	1050	912	372,12	1265	420,84	1617	473,34	1993	555,87	2369	653,94
22	1100	956	389,84	1325	440,88	1694	495,88	2088	582,34	2482	685,08
23	1150	999	407,56	1385	460,92	1771	518,42	2183	608,81	2595	716,22
24	1200	1043	425,28	1446	480,96	1848	540,96	2278	635,28	2707	747,36
25	1250	1086	443,00	1506	501,00	1925	563,50	2373	661,75	2820	778,50
26	1300	1129	460,72	1566	521,04	2002	586,04	2468	688,22	2933	809,64
27	1350	1173	478,44	1626	541,08	2079	608,58	2563	714,69	3046	840,78
28	1400	1216	496,16	1687	561,12	2156	631,12	2658	741,16	3159	871,92
29	1450	1260	513,88	1747	581,16	2233	653,66	2752	767,63	3272	903,06
30	1500	1303	531,60	1807	601,20	2310	676,20	2847	794,10	3384	934,20
31	1550	1347	549,32	1867	621,24	2387	698,74	2942	820,57	3497	965,34
32	1600	1390	567,04	1928	641,28	2464	721,28	3037	847,04	3610	996,48
33	1650	1434	584,76	1988	661,32	2541	743,82	3132	873,51	3723	1.027,62
34	1700	1477	602,48	2048	681,36	2619	766,36	3227	899,98	3836	1.058,76
35	1750	1521	620,20	2108	701,40	2696	788,90	3322	926,45	3949	1.089,90
36	1800	1564	637,92	2169	721,44	2773	811,44	3417	952,92	4061	1.121,04
37	1850	1608	655,64	2229	741,48	2850	833,98	3512	979,39	4174	1.152,18
38	1900	1651	673,36	2289	761,52	2927	856,52	3607	1.005,86	4287	1.183,32
39	1950	1694	691,08	2349	781,56	3004	879,06	3702	1.032,33	4400	1.214,46
40	2000	1738	708,80	2410	801,60	3081	901,60	3797	1.058,80	4513	1.245,60
41	2050	1781	726,52	2470	821,64	3158	924,14	3892	1.085,27	4626	1.276,74
42	2100	1825	744,24	2530	841,68	3235	946,68	3987	1.111,74	4738	1.307,88
43	2150	1868	761,96	2590	861,72	3312	969,22	4081	1.138,21	4851	1.339,02
44	2200	1912	779,68	2651	881,76	3389	991,76	4176	1.164,68	4964	1.370,16
45	2250	1955	797,40	2711	901,80	3466	1.014,30	4271	1.191,15	5077	1.401,30
46	2300	1999	815,12	2771	921,84	3543	1.036,84	4366	1.217,62	5190	1.432,44
47	2350	2042	832,84	2831	941,88	3620	1.059,38	4461	1.244,09	5303	1.463,58
48	2400	2086	850,56	2892	961,92	3697	1.081,92	4556	1.270,56	5415	1.494,72
49	2450	2129	868,28	2952	981,96	3774	1.104,46	4651	1.297,03	5528	1.525,86
50	2500	2173	886,00	3012	1.002,00	3851	1.127,00	4746	1.323,50	5641	1.557,00

LASERLINE
Standard

Grau hinterlegte Preise: Lieferung in einem Block möglich.

Druckfehler, technische und preisliche Änderungen vorbehalten. Unverbindliche Preisempfehlung exkl. MwSt. gültig ab 1.2.2016. Achtung: Für jede Produktgruppe gelten unterschiedliche Rabattsätze.

NORM-WÄRMELEISTUNG (WATT) BEI 75/65/20 °C NACH EN 442, DIN REGISTRIERNUMMER 6R0900

Die Preise verstehen sich ohne Befestigung.

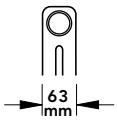
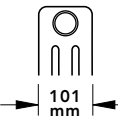
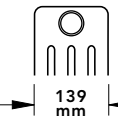
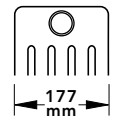
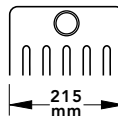
Bauhöhe [mm] 565		2-Säuler		3-Säuler		4-Säuler		5-Säuler		6-Säuler	
Nabenabstand 500 mm											
Modell		2057		3057		4057		5057		6057	
Leistung/Glied Watt		44,53		61,70		78,86		97,20		115,54	
Preis/Glied EUR		17,79		20,33		23,37		27,30		32,19	
Wasserin./Glied Liter		0,63		0,91		1,20		1,48		1,76	
Leergewicht/Glied kg		0,93		1,38		1,84		2,29		2,75	
Glieder	Bau- länge [mm]	Watt	EUR	Watt	EUR	Watt	EUR	Watt	EUR	Watt	EUR
4	200	178	71,16	246	81,32	315	93,48	388	109,20	462	128,76
5	250	222	88,95	308	101,65	394	116,85	486	136,50	577	160,95
6	300	267	106,74	370	121,98	473	140,22	583	163,80	693	193,14
7	350	311	124,53	431	142,31	552	163,59	680	191,10	808	225,33
8	400	356	142,32	493	162,64	630	186,96	777	218,40	924	257,52
9	450	400	160,11	555	182,97	709	210,33	874	245,70	1039	289,71
10	500	445	177,90	617	203,30	788	233,70	972	273,00	1155	321,90
11	550	489	195,69	678	223,63	867	257,07	1069	300,30	1270	354,09
12	600	534	213,48	740	243,96	946	280,44	1166	327,60	1386	386,28
13	650	578	231,27	802	264,29	1025	303,81	1263	354,90	1502	418,47
14	700	623	249,06	863	284,62	1104	327,18	1360	382,20	1617	450,66
15	750	667	266,85	925	304,95	1182	350,55	1458	409,50	1733	482,85
16	800	712	284,64	987	325,28	1261	373,92	1555	436,80	1848	515,04
17	850	757	302,43	1048	345,61	1340	397,29	1652	464,10	1964	547,23
18	900	801	320,22	1110	365,94	1419	420,66	1749	491,40	2079	579,42
19	950	846	338,01	1172	386,27	1498	444,03	1846	518,70	2195	611,61
20	1000	890	355,80	1234	406,60	1577	467,40	1944	546,00	2310	643,80
21	1050	935	373,59	1295	426,93	1656	490,77	2041	573,30	2426	675,99
22	1100	979	391,38	1357	447,26	1734	514,14	2138	600,60	2541	708,18
23	1150	1024	409,17	1419	467,59	1813	537,51	2235	627,90	2657	740,37
24	1200	1068	426,96	1480	487,92	1892	560,88	2332	655,20	2772	772,56
25	1250	1113	444,75	1542	508,25	1971	584,25	2430	682,50	2888	804,75
26	1300	1157	462,54	1604	528,58	2050	607,62	2527	709,80	3004	836,94
27	1350	1202	480,33	1665	548,91	2129	630,99	2624	737,10	3119	869,13
28	1400	1246	498,12	1727	569,24	2208	654,36	2721	764,40	3235	901,32
29	1450	1291	515,91	1789	589,57	2286	677,73	2818	791,70	3350	933,51
30	1500	1335	533,70	1851	609,90	2365	701,10	2916	819,00	3466	965,70
31	1550	1380	551,49	1912	630,23	2444	724,47	3013	846,30	3581	997,89
32	1600	1424	569,28	1974	650,56	2523	747,84	3110	873,60	3697	1.030,08
33	1650	1469	587,07	2036	670,89	2602	771,21	3207	900,90	3812	1.062,27
34	1700	1514	604,86	2097	691,22	2681	794,58	3304	928,20	3928	1.094,46
35	1750	1558	622,65	2159	711,55	2760	817,95	3402	955,50	4043	1.126,65
36	1800	1603	640,44	2221	731,88	2838	841,32	3499	982,80	4159	1.158,84
37	1850	1647	658,23	2282	752,21	2917	864,69	3596	1.010,10	4274	1.191,03
38	1900	1692	676,02	2344	772,54	2996	888,06	3693	1.037,40	4390	1.223,22
39	1950	1736	693,81	2406	792,87	3075	911,43	3790	1.064,70	4506	1.255,41
40	2000	1781	711,60	2468	813,20	3154	934,80	3888	1.092,00	4621	1.287,60
41	2050	1825	729,39	2529	833,53	3233	958,17	3985	1.119,30	4737	1.319,79
42	2100	1870	747,18	2591	853,86	3312	981,54	4082	1.146,60	4852	1.351,98
43	2150	1914	764,97	2653	874,19	3390	1.004,91	4179	1.173,90	4968	1.384,17
44	2200	1959	782,76	2714	894,52	3469	1.028,28	4276	1.201,20	5083	1.416,36
45	2250	2003	800,55	2776	914,85	3548	1.051,65	4374	1.228,50	5199	1.448,55
46	2300	2048	818,34	2838	935,18	3627	1.075,02	4471	1.255,80	5314	1.480,74
47	2350	2092	836,13	2899	955,51	3706	1.098,39	4568	1.283,10	5430	1.512,93
48	2400	2137	853,92	2961	975,84	3785	1.121,76	4665	1.310,40	5545	1.545,12
49	2450	2181	871,71	3023	996,17	3864	1.145,13	4762	1.337,70	5661	1.577,31
50	2500	2226	889,50	3085	1.016,50	3943	1.168,50	4860	1.365,00	5777	1.609,50

Druckfehler, technische und preisliche Änderungen vorbehalten. Unverbindliche Preisempfehlung exkl. MwSt. gültig ab 1.2.2016.
Achtung: Für jede Produktgruppe gelten unterschiedliche Rabattsätze.

Grau hinterlegte Preise: Lieferung in einem Block möglich.

NORM-WÄRMELEISTUNG (WATT) BEI 75/65/20 °C NACH EN 442, DIN REGISTRIERNUMMER 6R0900

Die Preise verstehen sich ohne Befestigung.

Bauhöhe [mm] 600		2-Säuler		3-Säuler		4-Säuler		5-Säuler		6-Säuler	
Nabenabstand 535 mm											
Modell		2060		3060		4060		5060		6060	
Leistung/Glied Watt		47,02		65,07		83,12		102,48		121,83	
Preis/Glied EUR		18,16		20,65		23,53		27,52		32,43	
Wasserin./Glied Liter		0,66		0,96		1,26		1,55		1,85	
Leergewicht/Glied kg		0,98		1,46		1,94		2,42		2,91	
Glieder	Bau- länge [mm]	Watt	EUR	Watt	EUR	Watt	EUR	Watt	EUR	Watt	EUR
4	200	188	72,64	260	82,60	332	94,12	409	110,08	487	129,72
5	250	235	90,80	325	103,25	415	117,65	512	137,60	609	162,15
6	300	282	108,96	390	123,90	498	141,18	614	165,12	730	194,58
7	350	329	127,12	455	144,55	581	164,71	717	192,64	852	227,01
8	400	376	145,28	520	165,20	664	188,24	819	220,16	974	259,44
9	450	423	163,44	585	185,85	748	211,77	922	247,68	1096	291,87
10	500	470	181,60	650	206,50	831	235,30	1024	275,20	1218	324,30
11	550	517	199,76	715	227,15	914	258,83	1127	302,72	1340	356,73
12	600	564	217,92	780	247,80	997	282,36	1229	330,24	1461	389,16
13	650	611	236,08	845	268,45	1080	305,89	1332	357,76	1583	421,59
14	700	658	254,24	910	289,10	1163	329,42	1434	385,28	1705	454,02
15	750	705	272,40	976	309,75	1246	352,95	1537	412,80	1827	486,45
16	800	752	290,56	1041	330,40	1329	376,48	1639	440,32	1949	518,88
17	850	799	308,72	1106	351,05	1413	400,01	1742	467,84	2071	551,31
18	900	846	326,88	1171	371,70	1496	423,54	1844	495,36	2192	583,74
19	950	893	345,04	1236	392,35	1579	447,07	1947	522,88	2314	616,17
20	1000	940	363,20	1301	413,00	1662	470,60	2049	550,40	2436	648,60
21	1050	987	381,36	1366	433,65	1745	494,13	2152	577,92	2558	681,03
22	1100	1034	399,52	1431	454,30	1828	517,66	2254	605,44	2680	713,46
23	1150	1081	417,68	1496	474,95	1911	541,19	2357	632,96	2802	745,89
24	1200	1128	435,84	1561	495,60	1994	564,72	2459	660,48	2923	778,32
25	1250	1175	454,00	1626	516,25	2078	588,25	2562	688,00	3045	810,75
26	1300	1222	472,16	1691	536,90	2161	611,78	2664	715,52	3167	843,18
27	1350	1269	490,32	1756	557,55	2244	635,31	2766	743,04	3289	875,61
28	1400	1316	508,48	1821	578,20	2327	658,84	2869	770,56	3411	908,04
29	1450	1363	526,64	1887	598,85	2410	682,37	2971	798,08	3533	940,47
30	1500	1410	544,80	1952	619,50	2493	705,90	3074	825,60	3654	972,90
31	1550	1457	562,96	2017	640,15	2576	729,43	3176	853,12	3776	1.005,33
32	1600	1504	581,12	2082	660,80	2659	752,96	3279	880,64	3898	1.037,76
33	1650	1551	599,28	2147	681,45	2742	776,49	3381	908,16	4020	1.070,19
34	1700	1598	617,44	2212	702,10	2826	800,02	3484	935,68	4142	1.102,62
35	1750	1645	635,60	2277	722,75	2909	823,55	3586	963,20	4264	1.135,05
36	1800	1692	653,76	2342	743,40	2992	847,08	3689	990,72	4385	1.167,48
37	1850	1739	671,92	2407	764,05	3075	870,61	3791	1.018,24	4507	1.199,91
38	1900	1786	690,08	2472	784,70	3158	894,14	3894	1.045,76	4629	1.232,34
39	1950	1833	708,24	2537	805,35	3241	917,67	3996	1.073,28	4751	1.264,77
40	2000	1880	726,40	2602	826,00	3324	941,20	4099	1.100,80	4873	1.297,20
41	2050	1927	744,56	2667	846,65	3407	964,73	4201	1.128,32	4995	1.329,63
42	2100	1974	762,72	2732	867,30	3491	988,26	4304	1.155,84	5116	1.362,06
43	2150	2021	780,88	2798	887,95	3574	1.011,79	4406	1.183,36	5238	1.394,49
44	2200	2068	799,04	2863	908,60	3657	1.035,32	4509	1.210,88	5360	1.426,92
45	2250	2115	817,20	2928	929,25	3740	1.058,85	4611	1.238,40	5482	1.459,35
46	2300	2162	835,36	2993	949,90	3823	1.082,38	4714	1.265,92	5604	1.491,78
47	2350	2209	853,52	3058	970,55	3906	1.105,91	4816	1.293,44	5726	1.524,21
48	2400	2256	871,68	3123	991,20	3989	1.129,44	4919	1.320,96	5847	1.556,64
49	2450	2303	889,84	3188	1.011,85	4072	1.152,97	5021	1.348,48	5969	1.589,07
50	2500	2351	908,00	3253	1.032,50	4156	1.176,50	5124	1.376,00	6091	1.621,50

LASERLINE
Standard

Grau hinterlegte Preise: Lieferung in einem Block möglich.

Druckfehler, technische und preisliche Änderungen vorbehalten. Unverbindliche Preisempfehlung exkl. MwSt. gültig ab 1.2.2016. Achtung: Für jede Produktgruppe gelten unterschiedliche Rabattsätze.

NORM-WÄRMELEISTUNG (WATT) BEI 75/65/20 °C NACH EN 442, DIN REGISTRIERNUMMER 6R0900

Die Preise verstehen sich ohne Befestigung.

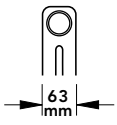
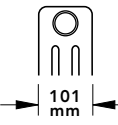
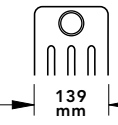
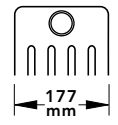
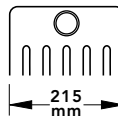
Bauhöhe [mm] 665		2-Säuler		3-Säuler		4-Säuler		5-Säuler		6-Säuler	
Nabenabstand 600 mm											
Modell		2067		3067		4067		5067		6067	
Leistung/Glied Watt		51,64		71,31		90,97		112,20		133,42	
Preis/Glied EUR		18,63		21,62		26,39		31,67		36,19	
Wasserin./Glied Liter		0,72		1,04		1,37		1,69		2,01	
Leergewicht/Glied kg		1,08		1,60		2,14		2,66		3,20	
Glieder	Bau- länge [mm]	Watt	EUR	Watt	EUR	Watt	EUR	Watt	EUR	Watt	EUR
4	200	206	74,52	285	86,48	363	105,56	448	126,68	533	144,76
5	250	258	93,15	356	108,10	454	131,95	561	158,35	667	180,95
6	300	309	111,78	427	129,72	545	158,34	673	190,02	800	217,14
7	350	361	130,41	499	151,34	636	184,73	785	221,69	933	253,33
8	400	413	149,04	570	172,96	727	211,12	897	253,36	1067	289,52
9	450	464	167,67	641	194,58	818	237,51	1009	285,03	1200	325,71
10	500	516	186,30	713	216,20	909	263,90	1122	316,70	1334	361,90
11	550	568	204,93	784	237,82	1000	290,29	1234	348,37	1467	398,09
12	600	619	223,56	855	259,44	1091	316,68	1346	380,04	1601	434,28
13	650	671	242,19	927	281,06	1182	343,07	1458	411,71	1734	470,47
14	700	722	260,82	998	302,68	1273	369,46	1570	443,38	1867	506,66
15	750	774	279,45	1069	324,30	1364	395,85	1683	475,05	2001	542,85
16	800	826	298,08	1140	345,92	1455	422,24	1795	506,72	2134	579,04
17	850	877	316,71	1212	367,54	1546	448,63	1907	538,39	2268	615,23
18	900	929	335,34	1283	389,16	1637	475,02	2019	570,06	2401	651,42
19	950	981	353,97	1354	410,78	1728	501,41	2131	601,73	2534	687,61
20	1000	1032	372,60	1426	432,40	1819	527,80	2244	633,40	2668	723,80
21	1050	1084	391,23	1497	454,02	1910	554,19	2356	665,07	2801	759,99
22	1100	1136	409,86	1568	475,64	2001	580,58	2468	696,74	2935	796,18
23	1150	1187	428,49	1640	497,26	2092	606,97	2580	728,41	3068	832,37
24	1200	1239	447,12	1711	518,88	2183	633,36	2692	760,08	3202	868,56
25	1250	1291	465,75	1782	540,50	2274	659,75	2805	791,75	3335	904,75
26	1300	1342	484,38	1854	562,12	2365	686,14	2917	823,42	3468	940,94
27	1350	1394	503,01	1925	583,74	2456	712,53	3029	855,09	3602	977,13
28	1400	1445	521,64	1996	605,36	2547	738,92	3141	886,76	3735	1.013,32
29	1450	1497	540,27	2067	626,98	2638	765,31	3253	918,43	3869	1.049,51
30	1500	1549	558,90	2139	648,60	2729	791,70	3366	950,10	4002	1.085,70
31	1550	1600	577,53	2210	670,22	2820	818,09	3478	981,77	4136	1.121,89
32	1600	1652	596,16	2281	691,84	2911	844,48	3590	1.013,44	4269	1.158,08
33	1650	1704	614,79	2353	713,46	3002	870,87	3702	1.045,11	4402	1.194,27
34	1700	1755	633,42	2424	735,08	3092	897,26	3814	1.076,78	4536	1.230,46
35	1750	1807	652,05	2495	756,70	3183	923,65	3927	1.108,45	4669	1.266,65
36	1800	1859	670,68	2567	778,32	3274	950,04	4039	1.140,12	4803	1.302,84
37	1850	1910	689,31	2638	799,94	3365	976,43	4151	1.171,79	4936	1.339,03
38	1900	1962	707,94	2709	821,56	3456	1.002,82	4263	1.203,46	5069	1.375,22
39	1950	2013	726,57	2781	843,18	3547	1.029,21	4375	1.235,13	5203	1.411,41
40	2000	2065	745,20	2852	864,80	3638	1.055,60	4488	1.266,80	5336	1.447,60
41	2050	2117	763,83	2923	886,42	3729	1.081,99	4600	1.298,47	5470	1.483,79
42	2100	2168	782,46	2995	908,04	3820	1.108,38	4712	1.330,14	5603	1.519,98
43	2150	2220	801,09	3066	929,66	3911	1.134,77	4824	1.361,81	5737	1.556,17
44	2200	2272	819,72	3137	951,28	4002	1.161,16	4936	1.393,48	5870	1.592,36
45	2250	2323	838,35	3208	972,90	4093	1.187,55	5049	1.425,15	6003	1.628,55
46	2300	2375	856,98	3280	994,52	4184	1.213,94	5161	1.456,82	6137	1.664,74
47	2350	2427	875,61	3351	1.016,14	4275	1.240,33	5273	1.488,49	6270	1.700,93
48	2400	2478	894,24	3422	1.037,76	4366	1.266,72	5385	1.520,16	6404	1.737,12
49	2450	2530	912,87	3494	1.059,38	4457	1.293,11	5497	1.551,83	6537	1.773,31
50	2500	2582	931,50	3565	1.081,00	4548	1.319,50	5610	1.583,50	6671	1.809,50

Druckfehler, technische und preisliche Änderungen vorbehalten. Unverbindliche Preisempfehlung exkl. MwSt. gültig ab 1.2.2016.
Achtung: Für jede Produktgruppe gelten unterschiedliche Rabattsätze.

Grau hinterlegte Preise: Lieferung in einem Block möglich.

NORM-WÄRMELEISTUNG (WATT) BEI 75/65/20 °C NACH EN 442, DIN REGISTRIERNUMMER 6R0900

Die Preise verstehen sich ohne Befestigung.

Bauhöhe [mm] 750		2-Säuler		3-Säuler		4-Säuler		5-Säuler		6-Säuler	
Modell		2075		3075		4075		5075		6075	
Leistung/Glied Watt		57,65		79,40		101,15		124,80		148,45	
Preis/Glied EUR		19,08		22,16		26,83		31,81		36,94	
Wasserin./Glied Liter		0,80		1,15		1,51		1,86		2,22	
Leergewicht/Glied kg		1,21		1,79		2,39		2,97		3,58	
Glieder	Bau- länge [mm]	Watt	EUR	Watt	EUR	Watt	EUR	Watt	EUR	Watt	EUR
4	200	230	76,32	317	88,64	404	107,32	499	127,24	593	147,76
5	250	288	95,40	397	110,80	505	134,15	624	159,05	742	184,70
6	300	345	114,48	476	132,96	606	160,98	748	190,86	890	221,64
7	350	403	133,56	555	155,12	708	187,81	873	222,67	1039	258,58
8	400	461	152,64	635	177,28	809	214,64	998	254,48	1187	295,52
9	450	518	171,72	714	199,44	910	241,47	1123	286,29	1336	332,46
10	500	576	190,80	794	221,60	1011	268,30	1248	318,10	1484	369,40
11	550	634	209,88	873	243,76	1112	295,13	1372	349,91	1632	406,34
12	600	691	228,96	952	265,92	1213	321,96	1497	381,72	1781	443,28
13	650	749	248,04	1032	288,08	1314	348,79	1622	413,53	1929	480,22
14	700	807	267,12	1111	310,24	1416	375,62	1747	445,34	2078	517,16
15	750	864	286,20	1191	332,40	1517	402,45	1872	477,15	2226	554,10
16	800	922	305,28	1270	354,56	1618	429,28	1996	508,96	2375	591,04
17	850	980	324,36	1349	376,72	1719	456,11	2121	540,77	2523	627,98
18	900	1037	343,44	1429	398,88	1820	482,94	2246	572,58	2672	664,92
19	950	1095	362,52	1508	421,04	1921	509,77	2371	604,39	2820	701,86
20	1000	1153	381,60	1588	443,20	2023	536,60	2496	636,20	2969	738,80
21	1050	1210	400,68	1667	465,36	2124	563,43	2620	668,01	3117	775,74
22	1100	1268	419,76	1746	487,52	2225	590,26	2745	699,82	3265	812,68
23	1150	1325	438,84	1826	509,68	2326	617,09	2870	731,63	3414	849,62
24	1200	1383	457,92	1905	531,84	2427	643,92	2995	763,44	3562	886,56
25	1250	1441	477,00	1985	554,00	2528	670,75	3120	795,25	3711	923,50
26	1300	1498	496,08	2064	576,16	2629	697,58	3244	827,06	3859	960,44
27	1350	1556	515,16	2143	598,32	2731	724,41	3369	858,87	4008	997,38
28	1400	1614	534,24	2223	620,48	2832	751,24	3494	890,68	4156	1.034,32
29	1450	1671	553,32	2302	642,64	2933	778,07	3619	922,49	4305	1.071,26
30	1500	1729	572,40	2382	664,80	3034	804,90	3744	954,30	4453	1.108,20
31	1550	1787	591,48	2461	686,96	3135	831,73	3868	986,11	4601	1.145,14
32	1600	1844	610,56	2540	709,12	3236	858,56	3993	1.017,92	4750	1.182,08
33	1650	1902	629,64	2620	731,28	3337	885,39	4118	1.049,73	4898	1.219,02
34	1700	1960	648,72	2699	753,44	3439	912,22	4243	1.081,54	5047	1.255,96
35	1750	2017	667,80	2779	775,60	3540	939,05	4368	1.113,35	5195	1.292,90
36	1800	2075	686,88	2858	797,76	3641	965,88	4492	1.145,16	5344	1.329,84
37	1850	2133	705,96	2937	819,92	3742	992,71	4617	1.176,97	5492	1.366,78
38	1900	2190	725,04	3017	842,08	3843	1.019,54	4742	1.208,78	5641	1.403,72
39	1950	2248	744,12	3096	864,24	3944	1.046,37	4867	1.240,59	5789	1.440,66
40	2000	2306	763,20	3176	886,40	4046	1.073,20	4992	1.272,40	5938	1.477,60
41	2050	2363	782,28	3255	908,56	4147	1.100,03	5116	1.304,21	6086	1.514,54
42	2100	2421	801,36	3334	930,72	4248	1.126,86	5241	1.336,02	6234	1.551,48
43	2150	2478	820,44	3414	952,88	4349	1.153,69	5366	1.367,83	6383	1.588,42
44	2200	2536	839,52	3493	975,04	4450	1.180,52	5491	1.399,64	6531	1.625,36
45	2250	2594	858,60	3573	997,20	4551	1.207,35	5616	1.431,45	6680	1.662,30
46	2300	2651	877,68	3652	1.019,36	4652	1.234,18	5740	1.463,26	6828	1.699,24
47	2350	2709	896,76	3731	1.041,52	4754	1.261,01	5865	1.495,07	6977	1.736,18
48	2400	2767	915,84	3811	1.063,68	4855	1.287,84	5990	1.526,88	7125	1.773,12
49	2450	2824	934,92	3890	1.085,84	4956	1.314,67	6115	1.558,69	7274	1.810,06
50	2500	2882	954,00	3970	1.108,00	5057	1.341,50	6240	1.590,50	7422	1.847,00

LASERLINE
Standard

Grau hinterlegte Preise: Lieferung in einem Block möglich.

Druckfehler, technische und preisliche Änderungen vorbehalten. Unverbindliche Preisempfehlung exkl. MwSt. gültig ab 1.2.2016. Achtung: Für jede Produktgruppe gelten unterschiedliche Rabattsätze.

NORM-WÄRMELEISTUNG (WATT) BEI 75/65/20 °C NACH EN 442, DIN REGISTRIERNUMMER 6R0900

Die Preise verstehen sich ohne Befestigung.

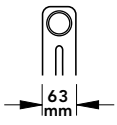
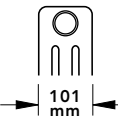
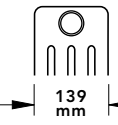
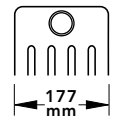
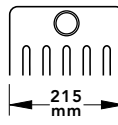
Bauhöhe [mm] 900		2-Säuler		3-Säuler		4-Säuler		5-Säuler		6-Säuler	
Nabenabstand 835 mm											
Modell		2090		3090		4090		5090		6090	
Leistung/Glied Watt		68,22		93,57		118,92		146,79		174,65	
Preis/Glied EUR		20,21		23,83		30,61		35,89		41,77	
Wasserin./Glied Liter		0,93		1,34		1,76		2,17		2,59	
Leergewicht/Glied kg		1,44		2,13		2,84		3,53		4,24	
Glieder	Bau- länge [mm]	Watt	EUR	Watt	EUR	Watt	EUR	Watt	EUR	Watt	EUR
4	200	272	80,84	374	95,32	475	122,44	587	143,56	698	167,08
5	250	341	101,05	467	119,15	594	153,05	733	179,45	873	208,85
6	300	409	121,26	561	142,98	713	183,66	880	215,34	1047	250,62
7	350	477	141,47	654	166,81	832	214,27	1027	251,23	1222	292,39
8	400	545	161,68	748	190,64	951	244,88	1174	287,12	1397	334,16
9	450	613	181,89	842	214,47	1070	275,49	1321	323,01	1571	375,93
10	500	682	202,10	935	238,30	1189	306,10	1467	358,90	1746	417,70
11	550	750	222,31	1029	262,13	1308	336,71	1614	394,79	1921	459,47
12	600	818	242,52	1122	285,96	1427	367,32	1761	430,68	2095	501,24
13	650	886	262,73	1216	309,79	1545	397,93	1908	466,57	2270	543,01
14	700	955	282,94	1309	333,62	1664	428,54	2055	502,46	2445	584,78
15	750	1023	303,15	1403	357,45	1783	459,15	2201	538,35	2619	626,55
16	800	1091	323,36	1497	381,28	1902	489,76	2348	574,24	2794	668,32
17	850	1159	343,57	1590	405,11	2021	520,37	2495	610,13	2969	710,09
18	900	1227	363,78	1684	428,94	2140	550,98	2642	646,02	3143	751,86
19	950	1296	383,99	1777	452,77	2259	581,59	2789	681,91	3318	793,63
20	1000	1364	404,20	1871	476,60	2378	612,20	2935	717,80	3493	835,40
21	1050	1432	424,41	1964	500,43	2497	642,81	3082	753,69	3667	877,17
22	1100	1500	444,62	2058	524,26	2616	673,42	3229	789,58	3842	918,94
23	1150	1569	464,83	2152	548,09	2735	704,03	3376	825,47	4016	960,71
24	1200	1637	485,04	2245	571,92	2854	734,64	3522	861,36	4191	1.002,48
25	1250	1705	505,25	2339	595,75	2973	765,25	3669	897,25	4366	1.044,25
26	1300	1773	525,46	2432	619,58	3091	795,86	3816	933,14	4540	1.086,02
27	1350	1841	545,67	2526	643,41	3210	826,47	3963	969,03	4715	1.127,79
28	1400	1910	565,88	2619	667,24	3329	857,08	4110	1.004,92	4890	1.169,56
29	1450	1978	586,09	2713	691,07	3448	887,69	4256	1.040,81	5064	1.211,33
30	1500	2046	606,30	2807	714,90	3567	918,30	4403	1.076,70	5239	1.253,10
31	1550	2114	626,51	2900	738,73	3686	948,91	4550	1.112,59	5414	1.294,87
32	1600	2183	646,72	2994	762,56	3805	979,52	4697	1.148,48	5588	1.336,64
33	1650	2251	666,93	3087	786,39	3924	1.010,13	4844	1.184,37	5763	1.378,41
34	1700	2319	687,14	3181	810,22	4043	1.040,74	4990	1.220,26	5938	1.420,18
35	1750	2387	707,35	3274	834,05	4162	1.071,35	5137	1.256,15	6112	1.461,95
36	1800	2455	727,56	3368	857,88	4281	1.101,96	5284	1.292,04	6287	1.503,72
37	1850	2524	747,77	3462	881,71	4400	1.132,57	5431	1.327,93	6462	1.545,49
38	1900	2592	767,98	3555	905,54	4518	1.163,18	5578	1.363,82	6636	1.587,26
39	1950	2660	788,19	3649	929,37	4637	1.193,79	5724	1.399,71	6811	1.629,03
40	2000	2728	808,40	3742	953,20	4756	1.224,40	5871	1.435,60	6986	1.670,80
41	2050	2797	828,61	3836	977,03	4875	1.255,01	6018	1.471,49	7160	1.712,57
42	2100	2865	848,82	3929	1.000,86	4994	1.285,62	6165	1.507,38	7335	1.754,34
43	2150	2933	869,03	4023	1.024,69	5113	1.316,23	6311	1.543,27	7509	1.796,11
44	2200	3001	889,24	4117	1.048,52	5232	1.346,84	6458	1.579,16	7684	1.837,88
45	2250	3069	909,45	4210	1.072,35	5351	1.377,45	6605	1.615,05	7859	1.879,65
46	2300	3138	929,66	4304	1.096,18	5470	1.408,06	6752	1.650,94	8033	1.921,42
47	2350	3206	949,87	4397	1.120,01	5589	1.438,67	6899	1.686,83	8208	1.963,19
48	2400	3274	970,08	4491	1.143,84	5708	1.469,28	7045	1.722,72	8383	2.004,96
49	2450	3342	990,29	4584	1.167,67	5827	1.499,89	7192	1.758,61	8557	2.046,73
50	2500	3411	1.010,50	4678	1.191,50	5946	1.530,50	7339	1.794,50	8732	2.088,50

Druckfehler, technische und preisliche Änderungen vorbehalten. Unverbindliche Preisempfehlung exkl. MwSt. gültig ab 1.2.2016.
Achtung: Für jede Produktgruppe gelten unterschiedliche Rabattsätze.

Grau hinterlegte Preise: Lieferung in einem Block möglich.

NORM-WÄRMELEISTUNG (WATT) BEI 75/65/20 °C NACH EN 442, DIN REGISTRIERNUMMER 6R0900

Die Preise verstehen sich ohne Befestigung.

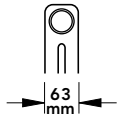
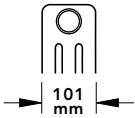
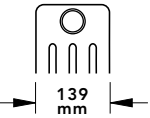
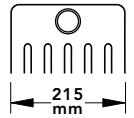
Bauhöhe [mm] 965		2-Säuler		3-Säuler		4-Säuler				6-Säuler	
Nabenabstand 900 mm											
Modell		2097		3097		4097				6097	
Leistung/Glied Watt		72,80		99,69		126,57				185,91	
Preis/Glied EUR		20,50		24,86		32,87				44,48	
Wasserin./Glied Liter		0,99		1,42		1,87				2,75	
Leergewicht/Glied kg		1,54		2,28		3,04				4,53	
Glieder	Bau- länge [mm]	Watt	EUR	Watt	EUR	Watt	EUR	Watt	EUR	Watt	EUR
4	200	291	82,00	398	99,44	506	131,48			743	177,92
5	250	364	102,50	498	124,30	632	164,35			929	222,40
6	300	436	123,00	598	149,16	759	197,22			1115	266,88
7	350	509	143,50	697	174,02	885	230,09			1301	311,36
8	400	582	164,00	797	198,88	1012	262,96			1487	355,84
9	450	655	184,50	897	223,74	1139	295,83			1673	400,32
10	500	728	205,00	996	248,60	1265	328,70			1859	444,80
11	550	800	225,50	1096	273,46	1392	361,57			2045	489,28
12	600	873	246,00	1196	298,32	1518	394,44			2230	533,76
13	650	946	266,50	1295	323,18	1645	427,31			2416	578,24
14	700	1019	287,00	1395	348,04	1771	460,18			2602	622,72
15	750	1092	307,50	1495	372,90	1898	493,05			2788	667,20
16	800	1164	328,00	1595	397,76	2025	525,92			2974	711,68
17	850	1237	348,50	1694	422,62	2151	558,79			3160	756,16
18	900	1310	369,00	1794	447,48	2278	591,66			3346	800,64
19	950	1383	389,50	1894	472,34	2404	624,53			3532	845,12
20	1000	1456	410,00	1993	497,20	2531	657,40			3718	889,60
21	1050	1528	430,50	2093	522,06	2657	690,27			3904	934,08
22	1100	1601	451,00	2193	546,92	2784	723,14			4090	978,56
23	1150	1674	471,50	2292	571,78	2911	756,01			4275	1.023,04
24	1200	1747	492,00	2392	596,64	3037	788,88			4461	1.067,52
25	1250	1820	512,50	2492	621,50	3164	821,75			4647	1.112,00
26	1300	1892	533,00	2591	646,36	3290	854,62			4833	1.156,48
27	1350	1965	553,50	2691	671,22	3417	887,49			5019	1.200,96
28	1400	2038	574,00	2791	696,08	3543	920,36			5205	1.245,44
29	1450	2111	594,50	2891	720,94	3670	953,23			5391	1.289,92
30	1500	2184	615,00	2990	745,80	3797	986,10			5577	1.334,40
31	1550	2256	635,50	3090	770,66	3923	1.018,97			5763	1.378,88
32	1600	2329	656,00	3190	795,52	4050	1.051,84			5949	1.423,36
33	1650	2402	676,50	3289	820,38	4176	1.084,71			6135	1.467,84
34	1700	2475	697,00	3389	845,24	4303	1.117,58			6320	1.512,32
35	1750	2548	717,50	3489	870,10	4429	1.150,45			6506	1.556,80
36	1800	2620	738,00	3588	894,96	4556	1.183,32			6692	1.601,28
37	1850	2693	758,50	3688	919,82	4683	1.216,19			6878	1.645,76
38	1900	2766	779,00	3788	944,68	4809	1.249,06			7064	1.690,24
39	1950	2839	799,50	3887	969,54	4936	1.281,93			7250	1.734,72
40	2000	2912	820,00	3987	994,40	5062	1.314,80			7436	1.779,20
41	2050	2984	840,50	4087	1.019,26	5189	1.347,67			7622	1.823,68
42	2100	3057	861,00	4186	1.044,12	5315	1.380,54			7808	1.868,16
43	2150	3130	881,50	4286	1.068,98	5442	1.413,41			7994	1.912,64
44	2200	3203	902,00	4386	1.093,84	5569	1.446,28			8180	1.957,12
45	2250	3276	922,50	4486	1.118,70	5695	1.479,15			8365	2.001,60
46	2300	3348	943,00	4585	1.143,56	5822	1.512,02			8551	2.046,08
47	2350	3421	963,50	4685	1.168,42	5948	1.544,89			8737	2.090,56
48	2400	3494	984,00	4785	1.193,28	6075	1.577,76			8923	2.135,04
49	2450	3567	1.004,50	4884	1.218,14	6201	1.610,63			9109	2.179,52
50	2500	3640	1.025,00	4984	1.243,00	6328	1.643,50			9295	2.224,00

LASERLINE
Standard

Grau hinterlegte Preise: Lieferung in einem Block möglich.

Druckfehler, technische und preisliche Änderungen vorbehalten. Unverbindliche Preisempfehlung exkl. MwSt. gültig ab 1.2.2016.
Achtung: Für jede Produktgruppe gelten unterschiedliche Rabattsätze.

NORM-WÄRMELEISTUNG (WATT) BEI 75/65/20 °C NACH EN 442, DIN REGISTRIERNUMMER 6R0900

Die Preise verstehen sich ohne Befestigung.

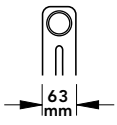
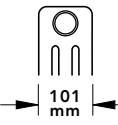
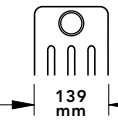
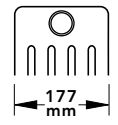
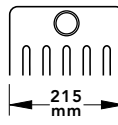
Bauhöhe [mm] 1000		2-Säuler		3-Säuler		4-Säuler		5-Säuler		6-Säuler	
Nabenabstand 935 mm											
Modell		2100		3100		4100		5100		6100	
Leistung/Glied Watt		75,26		102,97		130,67		161,31		191,95	
Preis/Glied EUR		20,98		24,94		33,02		38,46		45,08	
Wasserin./Glied Liter		1,02		1,47		1,93		2,38		2,84	
Leergewicht/Glied kg		1,59		2,36		3,14		3,91		4,69	
Glieder	Bau- länge [mm]	Watt	EUR	Watt	EUR	Watt	EUR	Watt	EUR	Watt	EUR
4	200	301	83,92	411	99,76	522	132,08	645	153,84	767	180,32
5	250	376	104,90	514	124,70	653	165,10	806	192,30	959	225,40
6	300	451	125,88	617	149,64	784	198,12	967	230,76	1151	270,48
7	350	526	146,86	720	174,58	914	231,14	1129	269,22	1343	315,56
8	400	602	167,84	823	199,52	1045	264,16	1290	307,68	1535	360,64
9	450	677	188,82	926	224,46	1176	297,18	1451	346,14	1727	405,72
10	500	752	209,80	1029	249,40	1306	330,20	1613	384,60	1919	450,80
11	550	827	230,78	1132	274,34	1437	363,22	1774	423,06	2111	495,88
12	600	903	251,76	1235	299,28	1568	396,24	1935	461,52	2303	540,96
13	650	978	272,74	1338	324,22	1698	429,26	2097	499,98	2495	586,04
14	700	1053	293,72	1441	349,16	1829	462,28	2258	538,44	2687	631,12
15	750	1128	314,70	1544	374,10	1960	495,30	2419	576,90	2879	676,20
16	800	1204	335,68	1647	399,04	2090	528,32	2580	615,36	3071	721,28
17	850	1279	356,66	1750	423,98	2221	561,34	2742	653,82	3263	766,36
18	900	1354	377,64	1853	448,92	2352	594,36	2903	692,28	3455	811,44
19	950	1429	398,62	1956	473,86	2482	627,38	3064	730,74	3647	856,52
20	1000	1505	419,60	2059	498,80	2613	660,40	3226	769,20	3839	901,60
21	1050	1580	440,58	2162	523,74	2744	693,42	3387	807,66	4030	946,68
22	1100	1655	461,56	2265	548,68	2874	726,44	3548	846,12	4222	991,76
23	1150	1730	482,54	2368	573,62	3005	759,46	3710	884,58	4414	1.036,84
24	1200	1806	503,52	2471	598,56	3136	792,48	3871	923,04	4606	1.081,92
25	1250	1881	524,50	2574	623,50	3266	825,50	4032	961,50	4798	1.127,00
26	1300	1956	545,48	2677	648,44	3397	858,52	4194	999,96	4990	1.172,08
27	1350	2032	566,46	2780	673,38	3528	891,54	4355	1.038,42	5182	1.217,16
28	1400	2107	587,44	2883	698,32	3658	924,56	4516	1.076,88	5374	1.262,24
29	1450	2182	608,42	2986	723,26	3789	957,58	4677	1.115,34	5566	1.307,32
30	1500	2257	629,40	3089	748,20	3920	990,60	4839	1.153,80	5758	1.352,40
31	1550	2333	650,38	3192	773,14	4050	1.023,62	5000	1.192,26	5950	1.397,48
32	1600	2408	671,36	3295	798,08	4181	1.056,64	5161	1.230,72	6142	1.442,56
33	1650	2483	692,34	3398	823,02	4312	1.089,66	5323	1.269,18	6334	1.487,64
34	1700	2558	713,32	3500	847,96	4442	1.122,68	5484	1.307,64	6526	1.532,72
35	1750	2634	734,30	3603	872,90	4573	1.155,70	5645	1.346,10	6718	1.577,80
36	1800	2709	755,28	3706	897,84	4704	1.188,72	5807	1.384,56	6910	1.622,88
37	1850	2784	776,26	3809	922,78	4834	1.221,74	5968	1.423,02	7102	1.667,96
38	1900	2859	797,24	3912	947,72	4965	1.254,76	6129	1.461,48	7294	1.713,04
39	1950	2935	818,22	4015	972,66	5096	1.287,78	6291	1.499,94	7486	1.758,12
40	2000	3010	839,20	4118	997,60	5226	1.320,80	6452	1.538,40	7678	1.803,20
41	2050	3085	860,18	4221	1.022,54	5357	1.353,82	6613	1.576,86	7869	1.848,28
42	2100	3160	881,16	4324	1.047,48	5488	1.386,84	6775	1.615,32	8061	1.893,36
43	2150	3236	902,14	4427	1.072,42	5618	1.419,86	6936	1.653,78	8253	1.938,44
44	2200	3311	923,12	4530	1.097,36	5749	1.452,88	7097	1.692,24	8445	1.983,52
45	2250	3386	944,10	4633	1.122,30	5880	1.485,90	7258	1.730,70	8637	2.028,60
46	2300	3461	965,08	4736	1.147,24	6010	1.518,92	7420	1.769,16	8829	2.073,68
47	2350	3537	986,06	4839	1.172,18	6141	1.551,94	7581	1.807,62	9021	2.118,76
48	2400	3612	1.007,04	4942	1.197,12	6272	1.584,96	7742	1.846,08	9213	2.163,84
49	2450	3687	1.028,02	5045	1.222,06	6402	1.617,98	7904	1.884,54	9405	2.208,92
50	2500	3763	1.049,00	5148	1.247,00	6533	1.651,00	8065	1.923,00	9597	2.254,00

Druckfehler, technische und preisliche Änderungen vorbehalten. Unverbindliche Preisempfehlung exkl. MwSt. gültig ab 1.2.2016.
Achtung: Für jede Produktgruppe gelten unterschiedliche Rabattsätze.

Grau hinterlegte Preise: Lieferung in einem Block möglich.

NORM-WÄRMELEISTUNG (WATT) BEI 75/65/20 °C NACH EN 442, DIN REGISTRIERNUMMER 6R0900

Die Preise verstehen sich ohne Befestigung.

Bauhöhe [mm] 1065		2-Säuler		3-Säuler		4-Säuler		5-Säuler		6-Säuler	
Nabenabstand 1000 mm											
Modell		2107		3107		4107		5107		6107	
Leistung/Glied Watt		72,71		109,07		138,29		170,72		203,15	
Preis/Glied EUR		22,40		27,90		36,73		43,34		51,26	
Wasserin./Glied Liter		1,04		1,55		2,04		2,52		3,00	
Leergewicht/Glied kg		1,76		2,46		3,24		4,15		4,98	
Glieder	Bau- länge [mm]	Watt	EUR	Watt	EUR	Watt	EUR	Watt	EUR	Watt	EUR
4	200	291	89,60	436	111,60	553	146,92	682	173,36	812	205,04
5	250	364	112,00	545	139,50	691	183,65	853	216,70	1015	256,30
6	300	436	134,40	654	167,40	829	220,38	1024	260,04	1218	307,56
7	350	509	156,80	763	195,30	968	257,11	1195	303,38	1422	358,82
8	400	582	179,20	872	223,20	1106	293,84	1365	346,72	1625	410,08
9	450	654	201,60	981	251,10	1244	330,57	1536	390,06	1828	461,34
10	500	727	224,00	1090	279,00	1382	367,30	1707	433,40	2031	512,60
11	550	800	246,40	1199	306,90	1521	404,03	1877	476,74	2234	563,86
12	600	873	268,80	1308	334,80	1659	440,76	2048	520,08	2437	615,12
13	650	945	291,20	1417	362,70	1797	477,49	2219	563,42	2640	666,38
14	700	1018	313,60	1526	390,60	1936	514,22	2390	606,76	2844	717,64
15	750	1091	336,00	1636	418,50	2074	550,95	2560	650,10	3047	768,90
16	800	1163	358,40	1745	446,40	2212	587,68	2731	693,44	3250	820,16
17	850	1236	380,80	1854	474,30	2350	624,41	2902	736,78	3453	871,42
18	900	1309	403,20	1963	502,20	2489	661,14	3072	780,12	3656	922,68
19	950	1381	425,60	2072	530,10	2627	697,87	3243	823,46	3859	973,94
20	1000	1454	448,00	2181	558,00	2765	734,60	3414	866,80	4063	1.025,20
21	1050	1527	470,40	2290	585,90	2904	771,33	3585	910,14	4266	1.076,46
22	1100	1600	492,80	2399	613,80	3042	808,06	3755	953,48	4469	1.127,72
23	1150	1672	515,20	2508	641,70	3180	844,79	3926	996,82	4672	1.178,98
24	1200	1745	537,60	2617	669,60	3318	881,52	4097	1.040,16	4875	1.230,24
25	1250	1818	560,00	2726	697,50	3457	918,25	4268	1.083,50	5078	1.281,50
26	1300	1890	582,40	2835	725,40	3595	954,98	4438	1.126,84	5281	1.332,76
27	1350	1963	604,80	2944	753,30	3733	991,71	4609	1.170,18	5485	1.384,02
28	1400	2036	627,20	3053	781,20	3872	1.028,44	4780	1.213,52	5688	1.435,28
29	1450	2109	649,60	3163	809,10	4010	1.065,17	4950	1.256,86	5891	1.486,54
30	1500	2181	672,00	3272	837,00	4148	1.101,90	5121	1.300,20	6094	1.537,80
31	1550	2254	694,40	3381	864,90	4286	1.138,63	5292	1.343,54	6297	1.589,06
32	1600	2327	716,80	3490	892,80	4425	1.175,36	5463	1.386,88	6500	1.640,32
33	1650	2399	739,20	3599	920,70	4563	1.212,09	5633	1.430,22	6703	1.691,58
34	1700	2472	761,60	3708	948,60	4701	1.248,82	5804	1.473,56	6907	1.742,84
35	1750	2545	784,00	3817	976,50	4840	1.285,55	5975	1.516,90	7110	1.794,10
36	1800	2618	806,40	3926	1.004,40	4978	1.322,28	6145	1.560,24	7313	1.845,36
37	1850	2690	828,80	4035	1.032,30	5116	1.359,01	6316	1.603,58	7516	1.896,62
38	1900	2763	851,20	4144	1.060,20	5255	1.395,74	6487	1.646,92	7719	1.947,88
39	1950	2836	873,60	4253	1.088,10	5393	1.432,47	6658	1.690,26	7922	1.999,14
40	2000	2908	896,00	4362	1.116,00	5531	1.469,20	6828	1.733,60	8126	2.050,40
41	2050	2981	918,40	4471	1.143,90	5669	1.505,93	6999	1.776,94	8329	2.101,66
42	2100	3054	940,80	4580	1.171,80	5808	1.542,66	7170	1.820,28	8532	2.152,92
43	2150	3127	963,20	4690	1.199,70	5946	1.579,39	7340	1.863,62	8735	2.204,18
44	2200	3199	985,60	4799	1.227,60	6084	1.616,12	7511	1.906,96	8938	2.255,44
45	2250	3272	1.008,00	4908	1.255,50	6223	1.652,85	7682	1.950,30	9141	2.306,70
46	2300	3345	1.030,40	5017	1.283,40	6361	1.689,58	7853	1.993,64	9344	2.357,96
47	2350	3417	1.052,80	5126	1.311,30	6499	1.726,31	8023	2.036,98	9548	2.409,22
48	2400	3490	1.075,20	5235	1.339,20	6637	1.763,04	8194	2.080,32	9751	2.460,48
49	2450	3563	1.097,60	5344	1.367,10	6776	1.799,77	8365	2.123,66	9954	2.511,74
50	2500	3636	1.120,00	5453	1.395,00	6914	1.836,50	8536	2.167,00	10157	2.563,00

LASERLINE
Standard

Grau hinterlegte Preise: Lieferung in einem Block möglich.

Druckfehler, technische und preisliche Änderungen vorbehalten. Unverbindliche Preisempfehlung exkl. MwSt. gültig ab 1.2.2016.
Achtung: Für jede Produktgruppe gelten unterschiedliche Rabattsätze.

NORM-WÄRMELEISTUNG (WATT) BEI 75/65/20 °C NACH EN 442, DIN REGISTRIERNUMMER 6R0900

Die Preise verstehen sich ohne Befestigung.

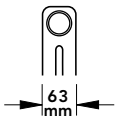
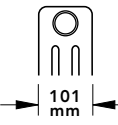
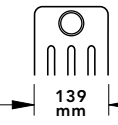
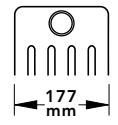
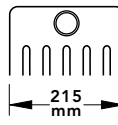
Bauhöhe [mm] 1100		2-Säuler		3-Säuler		4-Säuler		5-Säuler		6-Säuler	
Nabenabstand 1035 mm											
Modell		2110		3110		4110		5110		6110	
Leistung/Glied Watt		82,30		112,34		142,38		175,77		209,16	
Preis/Glied EUR		22,47		28,66		37,46		45,08		53,06	
Wasserin./Glied Liter		1,11		1,60		2,10		2,59		3,10	
Leergewicht/Glied kg		1,75		2,59		3,44		4,28		5,14	
Glieder	Bau- länge [mm]	Watt	EUR	Watt	EUR	Watt	EUR	Watt	EUR	Watt	EUR
4	200	329	89,88	449	114,64	569	149,84	703	180,32	836	212,24
5	250	411	112,35	561	143,30	711	187,30	878	225,40	1045	265,30
6	300	493	134,82	674	171,96	854	224,76	1054	270,48	1254	318,36
7	350	576	157,29	786	200,62	996	262,22	1230	315,56	1464	371,42
8	400	658	179,76	898	229,28	1139	299,68	1406	360,64	1673	424,48
9	450	740	202,23	1011	257,94	1281	337,14	1581	405,72	1882	477,54
10	500	823	224,70	1123	286,60	1423	374,60	1757	450,80	2091	530,60
11	550	905	247,17	1235	315,26	1566	412,06	1933	495,88	2300	583,66
12	600	987	269,64	1348	343,92	1708	449,52	2109	540,96	2509	636,72
13	650	1069	292,11	1460	372,58	1850	486,98	2285	586,04	2719	689,78
14	700	1152	314,58	1572	401,24	1993	524,44	2460	631,12	2928	742,84
15	750	1234	337,05	1685	429,90	2135	561,90	2636	676,20	3137	795,90
16	800	1316	359,52	1797	458,56	2278	599,36	2812	721,28	3346	848,96
17	850	1399	381,99	1909	487,22	2420	636,82	2988	766,36	3555	902,02
18	900	1481	404,46	2022	515,88	2562	674,28	3163	811,44	3764	955,08
19	950	1563	426,93	2134	544,54	2705	711,74	3339	856,52	3974	1.008,14
20	1000	1646	449,40	2246	573,20	2847	749,20	3515	901,60	4183	1.061,20
21	1050	1728	471,87	2359	601,86	2989	786,66	3691	946,68	4392	1.114,26
22	1100	1810	494,34	2471	630,52	3132	824,12	3866	991,76	4601	1.167,32
23	1150	1892	516,81	2583	659,18	3274	861,58	4042	1.036,84	4810	1.220,38
24	1200	1975	539,28	2696	687,84	3417	899,04	4218	1.081,92	5019	1.273,44
25	1250	2057	561,75	2808	716,50	3559	936,50	4394	1.127,00	5229	1.326,50
26	1300	2139	584,22	2920	745,16	3701	973,96	4570	1.172,08	5438	1.379,56
27	1350	2222	606,69	3033	773,82	3844	1.011,42	4745	1.217,16	5647	1.432,62
28	1400	2304	629,16	3145	802,48	3986	1.048,88	4921	1.262,24	5856	1.485,68
29	1450	2386	651,63	3257	831,14	4129	1.086,34	5097	1.307,32	6065	1.538,74
30	1500	2469	674,10	3370	859,80	4271	1.123,80	5273	1.352,40	6274	1.591,80
31	1550	2551	696,57	3482	888,46	4413	1.161,26	5448	1.397,48	6483	1.644,86
32	1600	2633	719,04	3594	917,12	4556	1.198,72	5624	1.442,56	6693	1.697,92
33	1650	2715	741,51	3707	945,78	4698	1.236,18	5800	1.487,64	6902	1.750,98
34	1700	2798	763,98	3819	974,44	4840	1.273,64	5976	1.532,72	7111	1.804,04
35	1750	2880	786,45	3931	1.003,10	4983	1.311,10	6151	1.577,80	7320	1.857,10
36	1800	2962	808,92	4044	1.031,76	5125	1.348,56	6327	1.622,88	7529	1.910,16
37	1850	3045	831,39	4156	1.060,42	5268	1.386,02	6503	1.667,96	7738	1.963,22
38	1900	3127	853,86	4268	1.089,08	5410	1.423,48	6679	1.713,04	7948	2.016,28
39	1950	3209	876,33	4381	1.117,74	5552	1.460,94	6855	1.758,12	8157	2.069,34
40	2000	3292	898,80	4493	1.146,40	5695	1.498,40	7030	1.803,20	8366	2.122,40
41	2050	3374	921,27	4605	1.175,06	5837	1.535,86	7206	1.848,28	8575	2.175,46
42	2100	3456	943,74	4718	1.203,72	5979	1.573,32	7382	1.893,36	8784	2.228,52
43	2150	3538	966,21	4830	1.232,38	6122	1.610,78	7558	1.938,44	8993	2.281,58
44	2200	3621	988,68	4942	1.261,04	6264	1.648,24	7733	1.983,52	9203	2.334,64
45	2250	3703	1.011,15	5055	1.289,70	6407	1.685,70	7909	2.028,60	9412	2.387,70
46	2300	3785	1.033,62	5167	1.318,36	6549	1.723,16	8085	2.073,68	9621	2.440,76
47	2350	3868	1.056,09	5279	1.347,02	6691	1.760,62	8261	2.118,76	9830	2.493,82
48	2400	3950	1.078,56	5392	1.375,68	6834	1.798,08	8436	2.163,84	10039	2.546,88
49	2450	4032	1.101,03	5504	1.404,34	6976	1.835,54	8612	2.208,92	10248	2.599,94
50	2500	4115	1.123,50	5617	1.433,00	7119	1.873,00	8788	2.254,00	10458	2.653,00

Druckfehler, technische und preisliche Änderungen vorbehalten. Unverbindliche Preisempfehlung exkl. MwSt. gültig ab 1.2.2016.
Achtung: Für jede Produktgruppe gelten unterschiedliche Rabattsätze.

Grau hinterlegte Preise: Lieferung in einem Block möglich.

NORM-WÄRMELEISTUNG (WATT) BEI 75/65/20 °C NACH EN 442, DIN REGISTRIERNUMMER 6R0900

Die Preise verstehen sich ohne Befestigung.

Bauhöhe [mm] 1200		2-Säuler		3-Säuler		4-Säuler		5-Säuler		6-Säuler	
Modell		2120		3120		4120		5120		6120	
Leistung/Glied Watt		89,35		121,70		154,04		190,17		226,29	
Preis/Glied EUR		24,43		33,00		41,54		51,41		60,00	
Wasserin./Glied Liter		1,19		1,73		2,27		2,80		3,33	
Leergewicht/Glied kg		1,90		2,81		3,74		4,65		5,58	
Glieder	Bau- länge [mm]	Watt	EUR	Watt	EUR	Watt	EUR	Watt	EUR	Watt	EUR
4	200	357	97,72	486	132,00	616	166,16	760	205,64	905	240,00
5	250	446	122,15	608	165,00	770	207,70	950	257,05	1131	300,00
6	300	536	146,58	730	198,00	924	249,24	1141	308,46	1357	360,00
7	350	625	171,01	851	231,00	1078	290,78	1331	359,87	1584	420,00
8	400	714	195,44	973	264,00	1232	332,32	1521	411,28	1810	480,00
9	450	804	219,87	1095	297,00	1386	373,86	1711	462,69	2036	540,00
10	500	893	244,30	1217	330,00	1540	415,40	1901	514,10	2262	600,00
11	550	982	268,73	1338	363,00	1694	456,94	2091	565,51	2489	660,00
12	600	1072	293,16	1460	396,00	1848	498,48	2282	616,92	2715	720,00
13	650	1161	317,59	1582	429,00	2002	540,02	2472	668,33	2941	780,00
14	700	1250	342,02	1703	462,00	2156	581,56	2662	719,74	3168	840,00
15	750	1340	366,45	1825	495,00	2310	623,10	2852	771,15	3394	900,00
16	800	1429	390,88	1947	528,00	2464	664,64	3042	822,56	3620	960,00
17	850	1518	415,31	2068	561,00	2618	706,18	3232	873,97	3846	1.020,00
18	900	1608	439,74	2190	594,00	2772	747,72	3423	925,38	4073	1.080,00
19	950	1697	464,17	2312	627,00	2926	789,26	3613	976,79	4299	1.140,00
20	1000	1787	488,60	2434	660,00	3080	830,80	3803	1.028,20	4525	1.200,00
21	1050	1876	513,03	2555	693,00	3234	872,34	3993	1.079,61	4752	1.260,00
22	1100	1965	537,46	2677	726,00	3388	913,88	4183	1.131,02	4978	1.320,00
23	1150	2055	561,89	2799	759,00	3542	955,42	4373	1.182,43	5204	1.380,00
24	1200	2144	586,32	2920	792,00	3696	996,96	4564	1.233,84	5430	1.440,00
25	1250	2233	610,75	3042	825,00	3851	1.038,50	4754	1.285,25	5657	1.500,00
26	1300	2323	635,18	3164	858,00	4005	1.080,04	4944	1.336,66	5883	1.560,00
27	1350	2412	659,61	3285	891,00	4159	1.121,58	5134	1.388,07	6109	1.620,00
28	1400	2501	684,04	3407	924,00	4313	1.163,12	5324	1.439,48	6336	1.680,00
29	1450	2591	708,47	3529	957,00	4467	1.204,66	5514	1.490,89	6562	1.740,00
30	1500	2680	732,90	3651	990,00	4621	1.246,20	5705	1.542,30	6788	1.800,00
31	1550	2769	757,33	3772	1.023,00	4775	1.287,74	5895	1.593,71	7014	1.860,00
32	1600	2859	781,76	3894	1.056,00	4929	1.329,28	6085	1.645,12	7241	1.920,00
33	1650	2948	806,19	4016	1.089,00	5083	1.370,82	6275	1.696,53	7467	1.980,00
34	1700	3037	830,62	4137	1.122,00	5237	1.412,36	6465	1.747,94	7693	2.040,00
35	1750	3127	855,05	4259	1.155,00	5391	1.453,90	6655	1.799,35	7920	2.100,00
36	1800	3216	879,48	4381	1.188,00	5545	1.495,44	6846	1.850,76	8146	2.160,00
37	1850	3305	903,91	4502	1.221,00	5699	1.536,98	7036	1.902,17	8372	2.220,00
38	1900	3395	928,34	4624	1.254,00	5853	1.578,52	7226	1.953,58	8599	2.280,00
39	1950	3484	952,77	4746	1.287,00	6007	1.620,06	7416	2.004,99	8825	2.340,00
40	2000	3574	977,20	4868	1.320,00	6161	1.661,60	7606	2.056,40	9051	2.400,00
41	2050	3663	1.001,63	4989	1.353,00	6315	1.703,14	7796	2.107,81	9277	2.460,00
42	2100	3752	1.026,06	5111	1.386,00	6469	1.744,68	7987	2.159,22	9504	2.520,00
43	2150	3842	1.050,49	5233	1.419,00	6623	1.786,22	8177	2.210,63	9730	2.580,00
44	2200	3931	1.074,92	5354	1.452,00	6777	1.827,76	8367	2.262,04	9956	2.640,00
45	2250	4020	1.099,35	5476	1.485,00	6931	1.869,30	8557	2.313,45	10183	2.700,00
46	2300	4110	1.123,78	5598	1.518,00	7085	1.910,84	8747	2.364,86	10409	2.760,00
47	2350	4199	1.148,21	5719	1.551,00	7239	1.952,38	8937	2.416,27	10635	2.820,00
48	2400	4288	1.172,64	5841	1.584,00	7393	1.993,92	9128	2.467,68	10861	2.880,00
49	2450	4378	1.197,07	5963	1.617,00	7547	2.035,46	9318	2.519,09	11088	2.940,00
50	2500	4467	1.221,50	6085	1.650,00	7702	2.077,00	9508	2.570,50	11314	3.000,00

LASERLINE
Standard

Grau hinterlegte Preise: Lieferung in einem Block möglich.

Druckfehler, technische und preisliche Änderungen vorbehalten. Unverbindliche Preisempfehlung exkl. MwSt. gültig ab 1.2.2016. Achtung: Für jede Produktgruppe gelten unterschiedliche Rabattsätze.

NORM-WÄRMELEISTUNG (WATT) BEI 75/65/20 °C NACH EN 442, DIN REGISTRIERNUMMER 6R0900

Die Preise verstehen sich ohne Befestigung.

Bauhöhe [mm] 1500		2-Säuler		3-Säuler		4-Säuler		5-Säuler		6-Säuler	
Nabenabstand 1435 mm											
Modell		2150		3150		4150		5150		6150	
Leistung/Glied Watt		110,64		149,80		188,95		233,18		277,41	
Preis/Glied EUR		31,06		42,89		56,01		69,21		82,64	
Wasserin./Glied Liter		1,46		2,11		2,77		3,42		4,08	
Leergewicht/Glied kg		2,36		3,49		4,64		5,77		6,92	
Glieder	Bau- länge [mm]	Watt	EUR	Watt	EUR	Watt	EUR	Watt	EUR	Watt	EUR
4	200	442	124,24	599	171,56	755	224,04	932	276,84	1109	330,56
5	250	553	155,30	749	214,45	944	280,05	1165	346,05	1387	413,20
6	300	663	186,36	898	257,34	1133	336,06	1399	415,26	1664	495,84
7	350	774	217,42	1048	300,23	1322	392,07	1632	484,47	1941	578,48
8	400	885	248,48	1198	343,12	1511	448,08	1865	553,68	2219	661,12
9	450	995	279,54	1348	386,01	1700	504,09	2098	622,89	2496	743,76
10	500	1106	310,60	1498	428,90	1889	560,10	2331	692,10	2774	826,40
11	550	1217	341,66	1647	471,79	2078	616,11	2564	761,31	3051	909,04
12	600	1327	372,72	1797	514,68	2267	672,12	2798	830,52	3328	991,68
13	650	1438	403,78	1947	557,57	2456	728,13	3031	899,73	3606	1.074,32
14	700	1548	434,84	2097	600,46	2645	784,14	3264	968,94	3883	1.156,96
15	750	1659	465,90	2247	643,35	2834	840,15	3497	1.038,15	4161	1.239,60
16	800	1770	496,96	2396	686,24	3023	896,16	3730	1.107,36	4438	1.322,24
17	850	1880	528,02	2546	729,13	3212	952,17	3964	1.176,57	4715	1.404,88
18	900	1991	559,08	2696	772,02	3401	1.008,18	4197	1.245,78	4993	1.487,52
19	950	2102	590,14	2846	814,91	3590	1.064,19	4430	1.314,99	5270	1.570,16
20	1000	2212	621,20	2996	857,80	3779	1.120,20	4663	1.384,20	5548	1.652,80
21	1050	2323	652,26	3145	900,69	3967	1.176,21	4896	1.453,41	5825	1.735,44
22	1100	2434	683,32	3295	943,58	4156	1.232,22	5129	1.522,62	6103	1.818,08
23	1150	2544	714,38	3445	986,47	4345	1.288,23	5363	1.591,83	6380	1.900,72
24	1200	2655	745,44	3595	1.029,36	4534	1.344,24	5596	1.661,04	6657	1.983,36
25	1250	2766	776,50	3745	1.072,25	4723	1.400,25	5829	1.730,25	6935	2.066,00
26	1300	2876	807,56	3894	1.115,14	4912	1.456,26	6062	1.799,46	7212	2.148,64
27	1350	2987	838,62	4044	1.158,03	5101	1.512,27	6295	1.868,67	7490	2.231,28
28	1400	3097	869,68	4194	1.200,92	5290	1.568,28	6529	1.937,88	7767	2.313,92
29	1450	3208	900,74	4344	1.243,81	5479	1.624,29	6762	2.007,09	8044	2.396,56
30	1500	3319	931,80	4494	1.286,70	5668	1.680,30	6995	2.076,30	8322	2.479,20
31	1550	3429	962,86	4643	1.329,59	5857	1.736,31	7228	2.145,51	8599	2.561,84
32	1600	3540	993,92	4793	1.372,48	6046	1.792,32	7461	2.214,72	8877	2.644,48
33	1650	3651	1.024,98	4943	1.415,37	6235	1.848,33	7694	2.283,93	9154	2.727,12
34	1700	3761	1.056,04	5093	1.458,26	6424	1.904,34	7928	2.353,14	9431	2.809,76
35	1750	3872	1.087,10	5243	1.501,15	6613	1.960,35	8161	2.422,35	9709	2.892,40
36	1800	3983	1.118,16	5392	1.544,04	6802	2.016,36	8394	2.491,56	9986	2.975,04
37	1850	4093	1.149,22	5542	1.586,93	6991	2.072,37	8627	2.560,77	10264	3.057,68
38	1900	4204	1.180,28	5692	1.629,82	7180	2.128,38	8860	2.629,98	10541	3.140,32
39	1950	4314	1.211,34	5842	1.672,71	7369	2.184,39	9094	2.699,19	10818	3.222,96
40	2000	4425	1.242,40	5992	1.715,60	7558	2.240,40	9327	2.768,40	11096	3.305,60
41	2050	4536	1.273,46	6141	1.758,49	7746	2.296,41	9560	2.837,61	11373	3.388,24
42	2100	4646	1.304,52	6291	1.801,38	7935	2.352,42	9793	2.906,82	11651	3.470,88
43	2150	4757	1.335,58	6441	1.844,27	8124	2.408,43	10026	2.976,03	11928	3.553,52
44	2200	4868	1.366,64	6591	1.887,16	8313	2.464,44	10259	3.045,24	12206	3.636,16
45	2250	4978	1.397,70	6741	1.930,05	8502	2.520,45	10493	3.114,45	12483	3.718,80
46	2300	5089	1.428,76	6891	1.972,94	8691	2.576,46	10726	3.183,66	12760	3.801,44
47	2350	5200	1.459,82	7041	2.015,83	8880	2.632,47	10959	3.252,87	13038	3.884,08
48	2400	5310	1.490,88	7191	2.058,72	9069	2.688,48	11192	3.322,08	13315	3.966,72
49	2450	5421	1.521,94	7341	2.101,61	9258	2.744,49	11425	3.391,29	13593	4.049,36
50	2500	5532	1.553,00	7491	2.144,50	9447	2.800,50	11659	3.460,50	13870	4.132,00

NORM-WÄRMELEISTUNG (WATT) BEI 75/65/20 °C NACH EN 442, DIN REGISTRIERNUMMER 6R0900

Die Preise verstehen sich ohne Befestigung.

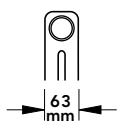
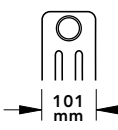
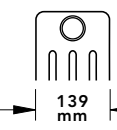
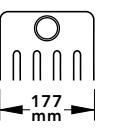
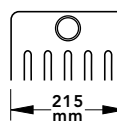
Bauhöhe [mm] 1800		2-Säuler 		3-Säuler 		4-Säuler 		5-Säuler 		6-Säuler 	
Nabenabstand 1735 mm		63 mm		101 mm		139 mm		177 mm		215 mm	
Modell		2180		3180		4180		5180		6180	
Leistung/Glied Watt		132,23		178,08		223,92		276,14		328,35	
Preis/Glied EUR		36,03		52,78		67,31		82,23		97,79	
Wasserin./Glied Liter		1,72		2,49		3,27		4,04		4,82	
Leergewicht/Glied kg		2,82		4,17		5,53		6,88		8,25	
Glieder	Bau- länge [mm]	Watt	EUR	Watt	EUR	Watt	EUR	Watt	EUR	Watt	EUR
4	200	528	144,12	712	211,12	895	269,24	1104	328,92	1313	391,16
5	250	661	180,15	890	263,90	1119	336,55	1380	411,15	1641	488,95
6	300	793	216,18	1068	316,68	1343	403,86	1656	493,38	1970	586,74
7	350	925	252,21	1246	369,46	1567	471,17	1932	575,61	2298	684,53
8	400	1057	288,24	1424	422,24	1791	538,48	2209	657,84	2626	782,32
9	450	1190	324,27	1602	475,02	2015	605,79	2485	740,07	2955	880,11
10	500	1322	360,30	1780	527,80	2239	673,10	2761	822,30	3283	977,90
11	550	1454	396,33	1958	580,58	2463	740,41	3037	904,53	3611	1.075,69
12	600	1586	432,36	2136	633,36	2687	807,72	3313	986,76	3940	1.173,48
13	650	1718	468,39	2315	686,14	2910	875,03	3589	1.068,99	4268	1.271,27
14	700	1851	504,42	2493	738,92	3134	942,34	3865	1.151,22	4596	1.369,06
15	750	1983	540,45	2671	791,70	3358	1.009,65	4142	1.233,45	4925	1.466,85
16	800	2115	576,48	2849	844,48	3582	1.076,96	4418	1.315,68	5253	1.564,64
17	850	2247	612,51	3027	897,26	3806	1.144,27	4694	1.397,91	5581	1.662,43
18	900	2380	648,54	3205	950,04	4030	1.211,58	4970	1.480,14	5910	1.760,22
19	950	2512	684,57	3383	1.002,82	4254	1.278,89	5246	1.562,37	6238	1.858,01
20	1000	2644	720,60	3561	1.055,60	4478	1.346,20	5522	1.644,60	6567	1.955,80
21	1050	2776	756,63	3739	1.108,38	4702	1.413,51	5798	1.726,83	6895	2.053,59
22	1100	2909	792,66	3917	1.161,16	4926	1.480,82	6075	1.809,06	7223	2.151,38
23	1150	3041	828,69	4095	1.213,94	5150	1.548,13	6351	1.891,29	7552	2.249,17
24	1200	3173	864,72	4273	1.266,72	5374	1.615,44	6627	1.973,52	7880	2.346,96
25	1250	3305	900,75	4452	1.319,50	5598	1.682,75	6903	2.055,75	8208	2.444,75
26	1300	3437	936,78	4630	1.372,28	5821	1.750,06	7179	2.137,98	8537	2.542,54
27	1350	3570	972,81	4808	1.425,06	6045	1.817,37	7455	2.220,21	8865	2.640,33
28	1400	3702	1.008,84	4986	1.477,84	6269	1.884,68	7731	2.302,44	9193	2.738,12
29	1450	3834	1.044,87	5164	1.530,62	6493	1.951,99	8008	2.384,67	9522	2.835,91
30	1500	3966	1.080,90	5342	1.583,40	6717	2.019,30	8284	2.466,90	9850	2.933,70
31	1550	4099	1.116,93	5520	1.636,18	6941	2.086,61	8560	2.549,13	10178	3.031,49
32	1600	4231	1.152,96	5698	1.688,96	7165	2.153,92	8836	2.631,36	10507	3.129,28
33	1650	4363	1.188,99	5876	1.741,74	7389	2.221,23	9112	2.713,59	10835	3.227,07
34	1700	4495	1.225,02	6054	1.794,52	7613	2.288,54	9388	2.795,82	11163	3.324,86
35	1750	4628	1.261,05	6232	1.847,30	7837	2.355,85	9664	2.878,05	11492	3.422,65
36	1800	4760	1.297,08	6410	1.900,08	8061	2.423,16	9941	2.960,28	11820	3.520,44
37	1850	4892	1.333,11	6588	1.952,86	8285	2.490,47	10217	3.042,51	12148	3.618,23
38	1900	5024	1.369,14	6767	2.005,64	8508	2.557,78	10493	3.124,74	12477	3.716,02
39	1950	5156	1.405,17	6945	2.058,42	8732	2.625,09	10769	3.206,97	12805	3.813,81
40	2000	5289	1.441,20	7123	2.111,20	8956	2.692,40	11045	3.289,20	13134	3.911,60
41	2050	5421	1.477,23	7301	2.163,98	9180	2.759,71	11321	3.371,43	13462	4.009,39
42	2100	5553	1.513,26	7479	2.216,76	9404	2.827,02	11597	3.453,66	13790	4.107,18
43	2150	5685	1.549,29	7657	2.269,54	9628	2.894,33	11874	3.535,89	14119	4.204,97
44	2200	5818	1.585,32	7835	2.322,32	9852	2.961,64	12150	3.618,12	14447	4.302,76
45	2250	5950	1.621,35	8013	2.375,10	10076	3.028,95	12426	3.700,35	14775	4.400,55
46	2300	6082	1.657,38	8191	2.427,88	10300	3.096,26	12702	3.782,58	15104	4.498,34
47	2350	6214	1.693,41	8369	2.480,66	10524	3.163,57	12978	3.864,81	15432	4.596,13
48	2400	6347	1.729,44	8547	2.533,44	10748	3.230,88	13254	3.947,04	15760	4.693,92
49	2450	6479	1.765,47	8725	2.586,22	10972	3.298,19	13530	4.029,27	16089	4.791,71
50	2500	6611	1.801,50	8904	2.639,00	11196	3.365,50	13807	4.111,50	16417	4.889,50

LASERLINE
Standard

Grau hinterlegte Preise: Lieferung in einem Block möglich.

Druckfehler, technische und preisliche Änderungen vorbehalten. Unverbindliche Preisempfehlung exkl. MwSt. gültig ab 1.2.2016. Achtung: Für jede Produktgruppe gelten unterschiedliche Rabattsätze.

NORM-WÄRMELEISTUNG (WATT) BEI 75/65/20 °C NACH EN 442, DIN REGISTRIERNUMMER 6R0900

Die Preise verstehen sich ohne Befestigung.

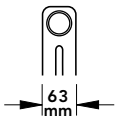
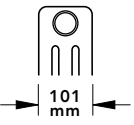
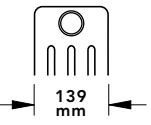
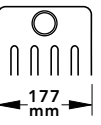
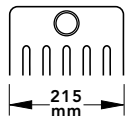
Bauhöhe [mm] 2000		2-Säuler		3-Säuler		4-Säuler		5-Säuler		6-Säuler	
Nabenabstand 1935 mm											
Modell		2200		3200		4200		5200		6200	
Leistung/Glied Watt		146,83		197,10		247,36		304,85		362,34	
Preis/Glied EUR		40,25		56,70		74,33		91,89		108,71	
Wasserin./Glied Liter		1,90		2,75		3,61		4,46		5,31	
Leergewicht/Glied kg		3,12		4,62		6,13		7,63		9,15	
Glieder	Bau- länge [mm]	Watt	EUR	Watt	EUR	Watt	EUR	Watt	EUR	Watt	EUR
4	200	587	161,00	788	226,80	989	297,32	1219	367,56	1449	434,84
5	250	734	201,25	985	283,50	1236	371,65	1524	459,45	1811	543,55
6	300	880	241,50	1182	340,20	1484	445,98	1829	551,34	2174	652,26
7	350	1027	281,75	1379	396,90	1731	520,31	2133	643,23	2536	760,97
8	400	1174	322,00	1576	453,60	1978	594,64	2438	735,12	2898	869,68
9	450	1321	362,25	1773	510,30	2226	668,97	2743	827,01	3261	978,39
10	500	1468	402,50	1971	567,00	2473	743,30	3048	918,90	3623	1.087,10
11	550	1615	442,75	2168	623,70	2720	817,63	3353	1.010,79	3985	1.195,81
12	600	1761	483,00	2365	680,40	2968	891,96	3658	1.102,68	4348	1.304,52
13	650	1908	523,25	2562	737,10	3215	966,29	3963	1.194,57	4710	1.413,23
14	700	2055	563,50	2759	793,80	3463	1.040,62	4267	1.286,46	5072	1.521,94
15	750	2202	603,75	2956	850,50	3710	1.114,95	4572	1.378,35	5435	1.630,65
16	800	2349	644,00	3153	907,20	3957	1.189,28	4877	1.470,24	5797	1.739,36
17	850	2496	684,25	3350	963,90	4205	1.263,61	5182	1.562,13	6159	1.848,07
18	900	2642	724,50	3547	1.020,60	4452	1.337,94	5487	1.654,02	6522	1.956,78
19	950	2789	764,75	3744	1.077,30	4699	1.412,27	5792	1.745,91	6884	2.065,49
20	1000	2936	805,00	3942	1.134,00	4947	1.486,60	6097	1.837,80	7246	2.174,20
21	1050	3083	845,25	4139	1.190,70	5194	1.560,93	6401	1.929,69	7609	2.282,91
22	1100	3230	885,50	4336	1.247,40	5441	1.635,26	6706	2.021,58	7971	2.391,62
23	1150	3377	925,75	4533	1.304,10	5689	1.709,59	7011	2.113,47	8333	2.500,33
24	1200	3523	966,00	4730	1.360,80	5936	1.783,92	7316	2.205,36	8696	2.609,04
25	1250	3670	1.006,25	4927	1.417,50	6184	1.858,25	7621	2.297,25	9058	2.717,75
26	1300	3817	1.046,50	5124	1.474,20	6431	1.932,58	7926	2.389,14	9420	2.826,46
27	1350	3964	1.086,75	5321	1.530,90	6678	2.006,91	8230	2.481,03	9783	2.935,17
28	1400	4111	1.127,00	5518	1.587,60	6926	2.081,24	8535	2.572,92	10145	3.043,88
29	1450	4258	1.167,25	5715	1.644,30	7173	2.155,57	8840	2.664,81	10507	3.152,59
30	1500	4404	1.207,50	5913	1.701,00	7420	2.229,90	9145	2.756,70	10870	3.261,30
31	1550	4551	1.247,75	6110	1.757,70	7668	2.304,23	9450	2.848,59	11232	3.370,01
32	1600	4698	1.288,00	6307	1.814,40	7915	2.378,56	9755	2.940,48	11594	3.478,72
33	1650	4845	1.328,25	6504	1.871,10	8162	2.452,89	10060	3.032,37	11957	3.587,43
34	1700	4992	1.368,50	6701	1.927,80	8410	2.527,22	10364	3.124,26	12319	3.696,14
35	1750	5139	1.408,75	6898	1.984,50	8657	2.601,55	10669	3.216,15	12681	3.804,85
36	1800	5285	1.449,00	7095	2.041,20	8904	2.675,88	10974	3.308,04	13044	3.913,56
37	1850	5432	1.489,25	7292	2.097,90	9152	2.750,21	11279	3.399,93	13406	4.022,27
38	1900	5579	1.529,50	7489	2.154,60	9399	2.824,54	11584	3.491,82	13768	4.130,98
39	1950	5726	1.569,75	7686	2.211,30	9647	2.898,87	11889	3.583,71	14131	4.239,69
40	2000	5873	1.610,00	7884	2.268,00	9894	2.973,20	12194	3.675,60	14493	4.348,40
41	2050	6020	1.650,25	8081	2.324,70	10141	3.047,53	12498	3.767,49	14855	4.457,11
42	2100	6166	1.690,50	8278	2.381,40	10389	3.121,86	12803	3.859,38	15218	4.565,82
43	2150	6313	1.730,75	8475	2.438,10	10636	3.196,19	13108	3.951,27	15580	4.674,53
44	2200	6460	1.771,00	8672	2.494,80	10883	3.270,52	13413	4.043,16	15942	4.783,24
45	2250	6607	1.811,25	8869	2.551,50	11131	3.344,85	13718	4.135,05	16305	4.891,95
46	2300	6754	1.851,50	9066	2.608,20	11378	3.419,18	14023	4.226,94	16667	5.000,66
47	2350	6901	1.891,75	9263	2.664,90	11625	3.493,51	14327	4.318,83	17029	5.109,37
48	2400	7047	1.932,00	9460	2.721,60	11873	3.567,84	14632	4.410,72	17392	5.218,08
49	2450	7194	1.972,25	9657	2.778,30	12120	3.642,17	14937	4.502,61	17754	5.326,79
50	2500	7341	2.012,50	9855	2.835,00	12368	3.716,50	15242	4.594,50	18117	5.435,50

Druckfehler, technische und preisliche Änderungen vorbehalten. Unverbindliche Preisempfehlung exkl. MwSt. gültig ab 1.2.2016. Achtung: Für jede Produktgruppe gelten unterschiedliche Rabattsätze.



Grau hinterlegte Preise: Lieferung in einem Block möglich.

NORM-WÄRMELEISTUNG (WATT) BEI 75/65/20 °C NACH EN 442, DIN REGISTRIERNUMMER 6R0900

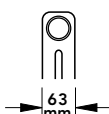
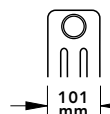
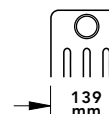
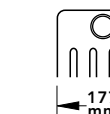
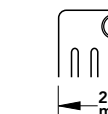
Die Preise verstehen sich ohne Befestigung.

Bauhöhe [mm] 2200		2-Säuler		3-Säuler		4-Säuler		5-Säuler		6-Säuler	
Nabenabstand 2135 mm											
Modell		2220		3220		4220		5220		6220	
Leistung/Glied Watt		161,63		216,28		270,93		333,68		396,42	
Preis/Glied EUR		45,23		64,09		82,93		101,78		119,88	
Wasserin./Glied Liter		2,08		3,01		3,94		4,87		5,81	
Leergewicht/Glied kg		3,43		5,07		6,73		8,38		10,04	
Glieder	Bau- länge [mm]	Watt	EUR	Watt	EUR	Watt	EUR	Watt	EUR	Watt	EUR
4	200	646	180,92	865	256,36	1083	331,72	1334	407,12	1585	479,52
5	250	808	226,15	1081	320,45	1354	414,65	1668	508,90	1982	599,40
6	300	969	271,38	1297	384,54	1625	497,58	2002	610,68	2378	719,28
7	350	1131	316,61	1513	448,63	1896	580,51	2335	712,46	2774	839,16
8	400	1293	361,84	1730	512,72	2167	663,44	2669	814,24	3171	959,04
9	450	1454	407,07	1946	576,81	2438	746,37	3003	916,02	3567	1.078,92
10	500	1616	452,30	2162	640,90	2709	829,30	3336	1.017,80	3964	1.198,80
11	550	1777	497,53	2379	704,99	2980	912,23	3670	1.119,58	4360	1.318,68
12	600	1939	542,76	2595	769,08	3251	995,16	4004	1.221,36	4757	1.438,56
13	650	2101	587,99	2811	833,17	3522	1.078,09	4337	1.323,14	5153	1.558,44
14	700	2262	633,22	3027	897,26	3793	1.161,02	4671	1.424,92	5549	1.678,32
15	750	2424	678,45	3244	961,35	4063	1.243,95	5005	1.526,70	5946	1.798,20
16	800	2586	723,68	3460	1.025,44	4334	1.326,88	5338	1.628,48	6342	1.918,08
17	850	2747	768,91	3676	1.089,53	4605	1.409,81	5672	1.730,26	6739	2.037,96
18	900	2909	814,14	3893	1.153,62	4876	1.492,74	6006	1.832,04	7135	2.157,84
19	950	3070	859,37	4109	1.217,71	5147	1.575,67	6339	1.933,82	7531	2.277,72
20	1000	3232	904,60	4325	1.281,80	5418	1.658,60	6673	2.035,60	7928	2.397,60
21	1050	3394	949,83	4541	1.345,89	5689	1.741,53	7007	2.137,38	8324	2.517,48
22	1100	3555	995,06	4758	1.409,98	5960	1.824,46	7340	2.239,16	8721	2.637,36
23	1150	3717	1.040,29	4974	1.474,07	6231	1.907,39	7674	2.340,94	9117	2.757,24
24	1200	3879	1.085,52	5190	1.538,16	6502	1.990,32	8008	2.442,72	9514	2.877,12
25	1250	4040	1.130,75	5407	1.602,25	6773	2.073,25	8342	2.544,50	9910	2.997,00

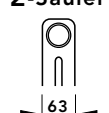
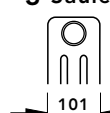
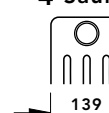
Die Preise verstehen sich ohne Befestigung.

Bauhöhe [mm] 2500		2-Säuler		3-Säuler		4-Säuler		5-Säuler		6-Säuler	
Nabenabstand 2435 mm											
Modell		2250		3250		4250		5250		6250	
Leistung/Glied Watt		184,23		245,44		306,30		377,21		447,78	
Preis/Glied EUR		50,89		72,59		93,46		114,27		135,99	
Wasserin./Glied Liter		2,34		3,39		4,45		5,50		6,55	
Leergewicht/Glied kg		3,89		5,75		7,63		9,49		11,37	
Glieder	Bau- länge [mm]	Watt	EUR	Watt	EUR	Watt	EUR	Watt	EUR	Watt	EUR
4	200	736	203,56	981	290,36	1225	373,84	1508	457,08	1791	543,96
5	250	921	254,45	1227	362,95	1532	467,30	1886	571,35	2238	679,95
6	300	1105	305,34	1472	435,54	1838	560,76	2263	685,62	2686	815,94
7	350	1289	356,23	1718	508,13	2144	654,22	2640	799,89	3134	951,93
8	400	1473	407,12	1963	580,72	2450	747,68	3017	914,16	3582	1.087,92
9	450	1658	458,01	2208	653,31	2757	841,14	3394	1.028,43	4030	1.223,91
10	500	1842	508,90	2454	725,90	3063	934,60	3772	1.142,70	4477	1.359,90
11	550	2026	559,79	2699	798,49	3369	1.028,06	4149	1.256,97	4925	1.495,89
12	600	2210	610,68	2945	871,08	3676	1.121,52	4526	1.371,24	5373	1.631,88
13	650	2394	661,57	3190	943,67	3982	1.214,98	4903	1.485,51	5821	1.767,87
14	700	2579	712,46	3436	1.016,26	4288	1.308,44	5280	1.599,78	6268	1.903,86
15	750	2763	763,35	3681	1.088,85	4595	1.401,90	5658	1.714,05	6716	2.039,85
16	800	2947	814,24	3927	1.161,44	4901	1.495,36	6035	1.828,32	7164	2.175,84
17	850	3131	865,13	4172	1.234,03	5207	1.588,82	6412	1.942,59	7612	2.311,83
18	900	3316	916,02	4417	1.306,62	5513	1.682,28	6789	2.056,86	8060	2.447,82
19	950	3500	966,91	4663	1.379,21	5820	1.775,74	7166	2.171,13	8507	2.583,81
20	1000	3684	1.017,80	4908	1.451,80	6126	1.869,20	7544	2.285,40	8955	2.719,80
21	1050	3868	1.068,69	5154	1.524,39	6432	1.962,66	7921	2.399,67	9403	2.855,79
22	1100	4053	1.119,58	5399	1.596,98	6739	2.056,12	8298	2.513,94	9851	2.991,78
23	1150	4237	1.170,47	5645	1.669,57	7045	2.149,58	8675	2.628,21	10298	3.127,77
24	1200	4421	1.221,36	5890	1.742,16	7351	2.243,04	9053	2.742,48	10746	3.263,76
25	1250	4605	1.272,25	6136	1.814,75	7658	2.336,50	9430	2.856,75	11194	3.399,75

LASERLINE Standard

Grau hinterlegte Preise: Lieferung in einem Block möglich.

Druckfehler, technische und preisliche Änderungen vorbehalten. Unverbindliche Preisempfehlung exkl. MwSt. gültig ab 1.2.2016. Achtung: Für jede Produktgruppe gelten unterschiedliche Rabattsätze.

NORM-WÄRMELEISTUNG (WATT) BEI 75/65/20 °C NACH EN 442, DIN REGISTRIERNUMMER 6R0900

Die Preise verstehen sich ohne Befestigung.

Bauhöhe [mm] 2800		Nabenabstand 2735 mm		2-Säuler 63 mm		3-Säuler 101 mm		4-Säuler 139 mm		5-Säuler 177 mm		6-Säuler 215 mm	
Modell		2280		3280		4280		5280		6280			
Leistung/Glied Watt		207,36		275,09		342,82		421,18		499,53			
Preis/Glied EUR		55,79		81,48		105,70		126,82		152,50			
Wasserin./Glied Liter		2,61		3,78		4,95		6,12		7,29			
Leergewicht/Glied kg		4,34		6,43		8,53		10,61		12,71			
Glieder	Bau- länge [mm]	Watt	EUR	Watt	EUR	Watt	EUR	Watt	EUR	Watt	EUR		
4	200	829	223,16	1100	325,92	1371	422,80	1684	507,28	1998	610,00		
5	250	1036	278,95	1375	407,40	1714	528,50	2105	634,10	2497	762,50		
6	300	1244	334,74	1650	488,88	2056	634,20	2527	760,92	2997	915,00		
7	350	1451	390,53	1925	570,36	2399	739,90	2948	887,74	3496	1.067,50		
8	400	1658	446,32	2200	651,84	2742	845,60	3369	1.014,56	3996	1.220,00		
9	450	1866	502,11	2475	733,32	3085	951,30	3790	1.141,38	4495	1.372,50		
10	500	2073	557,90	2750	814,80	3428	1.057,00	4211	1.268,20	4995	1.525,00		
11	550	2280	613,69	3025	896,28	3771	1.162,70	4632	1.395,02	5494	1.677,50		
12	600	2488	669,48	3301	977,76	4113	1.268,40	5054	1.521,84	5994	1.830,00		
13	650	2695	725,27	3576	1.059,24	4456	1.374,10	5475	1.648,66	6493	1.982,50		
14	700	2903	781,06	3851	1.140,72	4799	1.479,80	5896	1.775,48	6993	2.135,00		
15	750	3110	836,85	4126	1.222,20	5142	1.585,50	6317	1.902,30	7492	2.287,50		
16	800	3317	892,64	4401	1.303,68	5485	1.691,20	6738	2.029,12	7992	2.440,00		
17	850	3525	948,43	4676	1.385,16	5827	1.796,90	7160	2.155,94	8492	2.592,50		
18	900	3732	1.004,22	4951	1.466,64	6170	1.902,60	7581	2.282,76	8991	2.745,00		
19	950	3939	1.060,01	5226	1.548,12	6513	2.008,30	8002	2.409,58	9491	2.897,50		
20	1000	4147	1.115,80	5501	1.629,60	6856	2.114,00	8423	2.536,40	9990	3.050,00		
21	1050	4354	1.171,59	5776	1.711,08	7199	2.219,70	8844	2.663,22	10490	3.202,50		
22	1100	4561	1.227,38	6051	1.792,56	7542	2.325,40	9265	2.790,04	10989	3.355,00		
23	1150	4769	1.283,17	6327	1.874,04	7884	2.431,10	9687	2.916,86	11489	3.507,50		
24	1200	4976	1.338,96	6602	1.955,52	8227	2.536,80	10108	3.043,68	11988	3.660,00		
25	1250	5184	1.394,75	6877	2.037,00	8570	2.642,50	10529	3.170,50	12488	3.812,50		

Die Preise verstehen sich ohne Befestigung.

Bauhöhe [mm] 3000		Nabenabstand 2935 mm		2-Säuler 63 mm		3-Säuler 101 mm		4-Säuler 139 mm		5-Säuler 177 mm		6-Säuler 215 mm	
Modell		2300		3300		4300		5300		6300			
Leistung/Glied Watt		223,10		295,18		367,25		450,78		534,30			
Preis/Glied EUR		58,81		87,46		112,32		135,69		162,06			
Wasserin./Glied Liter		2,79		4,03		5,29		6,53		7,79			
Leergewicht/Glied kg		4,65		6,88		9,12		11,35		13,60			
Glieder	Bau- länge [mm]	Watt	EUR	Watt	EUR	Watt	EUR	Watt	EUR	Watt	EUR		
4	200	892	235,24	1180	349,84	1469	449,28	1803	542,76	2137	648,24		
5	250	1115	294,05	1475	437,30	1836	561,60	2253	678,45	2671	810,30		
6	300	1338	352,86	1771	524,76	2203	673,92	2704	814,14	3205	972,36		
7	350	1561	411,67	2066	612,22	2570	786,24	3155	949,83	3740	1.134,42		
8	400	1784	470,48	2361	699,68	2938	898,56	3606	1.085,52	4274	1.296,48		
9	450	2007	529,29	2656	787,14	3305	1.010,88	4057	1.221,21	4808	1.458,54		
10	500	2231	588,10	2951	874,60	3672	1.123,20	4507	1.356,90	5343	1.620,60		
11	550	2454	646,91	3246	962,06	4039	1.235,52	4958	1.492,59	5877	1.782,66		
12	600	2677	705,72	3542	1.049,52	4407	1.347,84	5409	1.628,28	6411	1.944,72		
13	650	2900	764,53	3837	1.136,98	4774	1.460,16	5860	1.763,97	6945	2.106,78		
14	700	3123	823,34	4132	1.224,44	5141	1.572,48	6310	1.899,66	7480	2.268,84		
15	750	3346	882,15	4427	1.311,90	5508	1.684,80	6761	2.035,35	8014	2.430,90		
16	800	3569	940,96	4722	1.399,36	5876	1.797,12	7212	2.171,04	8548	2.592,96		
17	850	3792	999,77	5018	1.486,82	6243	1.909,44	7663	2.306,73	9083	2.755,02		
18	900	4015	1.058,58	5313	1.574,28	6610	2.021,76	8114	2.442,42	9617	2.917,08		
19	950	4238	1.117,39	5608	1.661,74	6977	2.134,08	8564	2.578,11	10151	3.079,14		
20	1000	4462	1.176,20	5903	1.749,20	7345	2.246,40	9015	2.713,80	10686	3.241,20		
21	1050	4685	1.235,01	6198	1.836,66	7712	2.358,72	9466	2.849,49	11220	3.403,26		
22	1100	4908	1.293,82	6493	1.924,12	8079	2.471,04	9917	2.985,18	11754	3.565,32		
23	1150	5131	1.352,63	6789	2.011,58	8446	2.583,36	10367	3.120,87	12288	3.727,38		
24	1200	5354	1.411,44	7084	2.099,04	8814	2.695,68	10818	3.256,56	12823	3.889,44		
25	1250	5577	1.470,25	7379	2.186,50	9181	2.808,00	11269	3.392,25	13357	4.051,50		

Druckfehler, technische und preisliche Änderungen vorbehalten. Unverbindliche Preisempfehlung exkl. MwSt. gültig ab 1.2.2016.
 Achtung: Für jede Produktgruppe gelten unterschiedliche Rabattsätze.

Grau hinterlegte Preise: Lieferung in einem Block möglich.

PREISE		
Mehrpreise Sonderausführungen	Artikel-Nr.	Preis in EUR oder Mehrpreis in %
Anschluss nach oben oder unten, je		23,37
Anschluss für Einrohrventil vertikal 1/2"		23,37
Anschluss für Einrohrventil horizontal 1/2"		0,00
Blindscheibe 100 % dicht eingeschweißt		25,64
Stauscheibe mit Ø 13 mm Bohrung		25,64
RAL-Farbtöne außer RAL 9016		30 %
Sanitärfarbtöne und Spezialfarben		30 %
Angeschweißte Haltetaschen pro Stück		15,09
verzinkte Ausführung		100 % (Modelle auf Anfrage)
gewinkelte Ausführung pro Winkelstelle	YXIC200D90AA	133,19
gebogene Ausführung pro Glied	YXIC100D90AA	22,83
Nippeln von Radiatoren, werkseitig	YXIC300D90AA	62,94
Sonderbauhöhen zwischen 300 und 3000 mm (gewünschter Nabenabstand in mm + 65 mm = Gesamtbauhöhe)		Preis von nächster Standardhöhe
Ausführung mit Erdungslasche		44,52

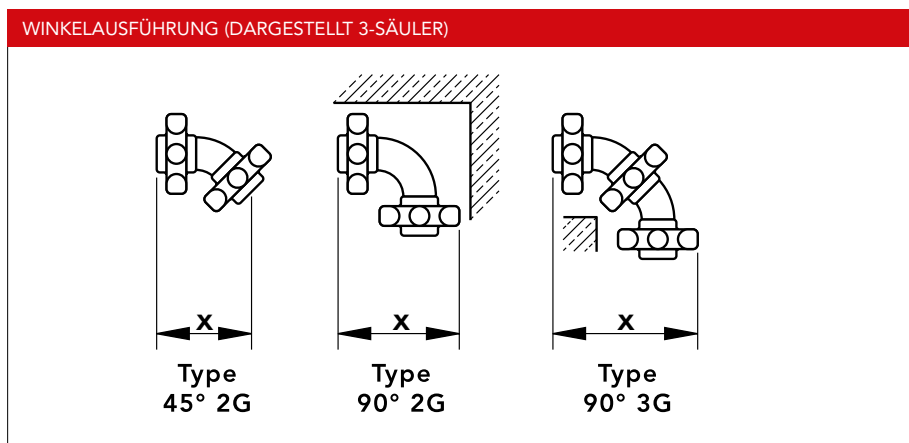
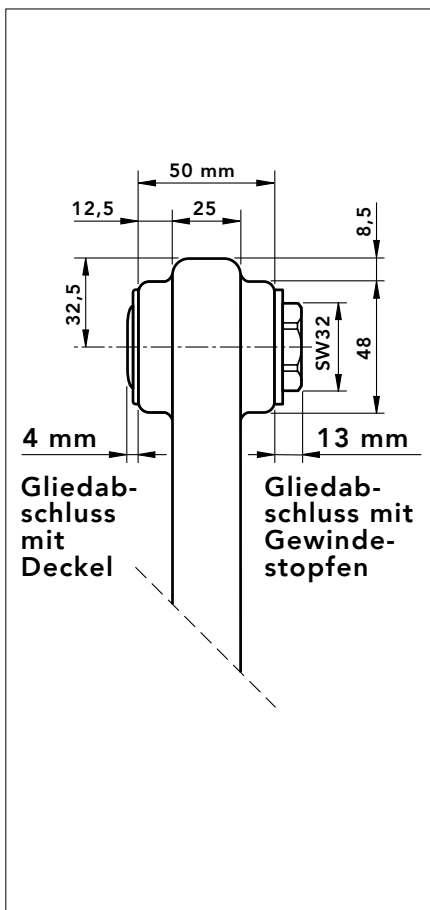

LASERLINE
Standard

	X [mm]				
Type	2-Säuler	3-Säuler	4-Säuler	5-Säuler	6-Säuler
45° 2G	110	120	133	148	163
90° 2G	135	154	190	227	266
90° 3G	152	184	222	262	302
Andere Winkelausführungen auf Anfrage					



LASERLINE VENTIL-MITTENANSCHLUSS

NORM-WÄRMELEISTUNG (WATT) BEI 75/65/20 °C NACH EN 442, DIN REGISTRIERNUMMER 6R0900

Achtung: Die Bauhöhe 155 mm kann nicht mit Radiatorenhalter montiert werden! Die Preise verstehen sich ohne Befestigung.

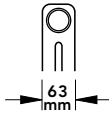
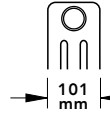
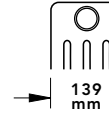
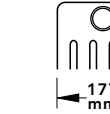
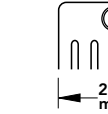
Bauhöhe [mm] 155		2-Säuler		3-Säuler		4-Säuler		5-Säuler		6-Säuler	
Nabenabstand 90 mm											
Modell		2016		3016		4016		5016		6016	
Leistung/Glied Watt		12,66		17,51		22,83		28,71		34,80	
Wasserin./Glied Liter		0,27		0,39		0,51		0,63		0,75	
Leergewicht/Glied kg		0,30		0,45		0,61		0,76		0,93	
Glieder	Bau- länge [mm]	Watt	EUR	Watt	EUR	Watt	EUR	Watt	EUR	Watt	EUR
4	200	50	244,43	70	248,03	91	257,07	114	272,11	139	287,19
6	300	75	275,83	105	281,23	136	294,79	172	317,35	208	339,97
8	400	101	307,23	140	314,43	182	332,51	229	362,59	278	392,75
10	500	126	338,63	175	347,63	228	370,23	287	407,83	348	445,53
12	600	151	370,03	210	380,83	273	407,95	344	453,07	417	498,31
14	700	177	401,43	245	414,03	319	445,67	401	498,31	487	551,09
16	800	202	432,83	280	447,23	365	483,39	459	543,55	556	603,87
18	900	227	464,23	315	480,43	410	521,11	516	588,79	626	656,65
20	1000	253	495,63	350	513,63	456	558,83	574	634,03	696	709,43
22	1100	278	527,03	385	546,83	502	596,55	631	679,27	765	762,21
24	1200	303	558,43	420	580,03	547	634,27	689	724,51	835	814,99
26	1300	329	589,83	455	613,23	593	671,99	746	769,75	904	867,77
28	1400	354	621,23	490	646,43	639	709,71	803	814,99	974	920,55
30	1500	379	652,63	525	679,63	684	747,43	861	860,23	1044	973,33

Die Preise verstehen sich ohne Befestigung.

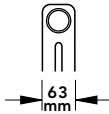
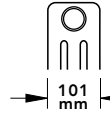
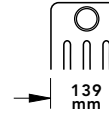
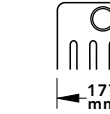
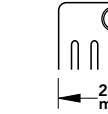
Bauhöhe [mm] 300		2-Säuler		3-Säuler		4-Säuler		5-Säuler		6-Säuler	
Nabenabstand 235 mm											
Modell		2030		3030		4030		5030		6030	
Leistung/Glied Watt		25,24		35,40		45,56		55,98		66,39	
Wasserin./Glied Liter		0,40		0,57		0,75		0,93		1,11	
Leergewicht/Glied kg		0,52		0,78		1,05		1,30		1,57	
Glieder	Bau- länge [mm]	Watt	EUR	Watt	EUR	Watt	EUR	Watt	EUR	Watt	EUR
4	200	100	244,91	141	250,11	182	258,51	223	273,23	265	288,63
6	300	151	276,55	212	284,35	273	296,95	335	319,03	398	342,13
8	400	201	308,19	283	318,59	364	335,39	447	364,83	531	395,63
10	500	252	339,83	354	352,83	455	373,83	559	410,63	663	449,13
12	600	302	371,47	424	387,07	546	412,27	671	456,43	796	502,63
14	700	353	403,11	495	421,31	637	450,71	783	502,23	929	556,13
16	800	403	434,75	566	455,55	728	489,15	895	548,03	1062	609,63
18	900	454	466,39	637	489,79	820	527,59	1007	593,83	1195	663,13
20	1000	504	498,03	708	524,03	911	566,03	1119	639,63	1327	716,63
22	1100	555	529,67	778	558,27	1002	604,47	1231	685,43	1460	770,13
24	1200	605	561,31	849	592,51	1093	642,91	1343	731,23	1593	823,63
26	1300	656	592,95	920	626,75	1184	681,35	1455	777,03	1726	877,13
28	1400	706	624,59	991	660,99	1275	719,79	1567	822,83	1858	930,63
30	1500	757	656,23	1062	695,23	1366	758,23	1679	868,63	1991	984,13



ULOW-E2

Profil-
heizkörper

Plan-
heizkörper

Vertikal-
heizkörper

Zubehör



Noppen-
system

Klett-system

Tacker-
system

Verlegeschie-
nensystem

Gittermatten-
system

Trocken-
system

Zubehör



Bad-
heizkörper

Design-
heizkörper

Elektro-
heizkörper





LASERLINE
Standard



LASERLINE
Mitte

LASERLINE VENTIL-MITTENANSCHLUSS

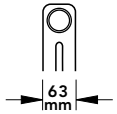
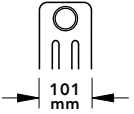
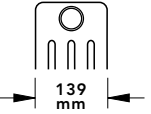
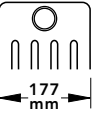
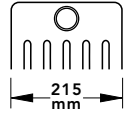
PREISE UND LEISTUNGEN

NORM-WÄRMELEISTUNG (WATT) BEI 75/65/20 °C NACH EN 442, DIN REGISTRIERNUMMER 6R0900

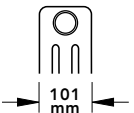
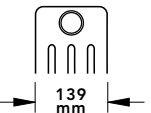
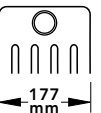
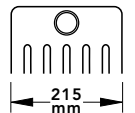
Die Preise verstehen sich ohne Befestigung.											
 Bauhöhe [mm] 350	2-Säuler		3-Säuler		4-Säuler		5-Säuler		6-Säuler		
	 63 mm		 101 mm		 139 mm		 177 mm		 215 mm		
 Nabenabstand 285 mm	Modell		Modell		Modell		Modell		Modell		
	2035		3035		4035		5035		6035		
Leistung/Glied Watt	28,96		40,50		52,04		63,99		75,93		
Wasserin./Glied Liter	0,44		0,64		0,84		1,03		1,23		
Leergewicht/Glied kg	0,60		0,89		1,20		1,49		1,86		
Glieder	 Bau- länge [mm]	Watt	EUR	Watt	EUR	Watt	EUR	Watt	EUR	Watt	EUR
4	200	115	246,43	162	252,19	208	260,91	255	275,75	303	291,95
6	300	173	278,83	243	287,47	312	300,55	383	322,81	455	347,11
8	400	231	311,23	324	322,75	416	340,19	511	369,87	607	402,27
10	500	289	343,63	405	358,03	520	379,83	639	416,93	759	457,43
12	600	347	376,03	486	393,31	624	419,47	767	463,99	911	512,59
14	700	405	408,43	567	428,59	728	459,11	895	511,05	1063	567,75
16	800	463	440,83	648	463,87	832	498,75	1023	558,11	1214	622,91
18	900	521	473,23	729	499,15	936	538,39	1151	605,17	1366	678,07
20	1000	579	505,63	810	534,43	1040	578,03	1279	652,23	1518	733,23
22	1100	637	538,03	891	569,71	1144	617,67	1407	699,29	1670	788,39
24	1200	695	570,43	972	604,99	1248	657,31	1535	746,35	1822	843,55
26	1300	752	602,83	1053	640,27	1353	696,95	1663	793,41	1974	898,71
28	1400	810	635,23	1134	675,55	1457	736,59	1791	840,47	2126	953,87
30	1500	868	667,63	1215	710,83	1561	776,23	1919	887,53	2277	1.009,03

Die Preise verstehen sich ohne Befestigung.											
 Bauhöhe [mm] 365	3-Säuler		4-Säuler		5-Säuler		6-Säuler				
	 101 mm		 139 mm		 177 mm		 215 mm				
 Nabenabstand 300 mm	Modell		Modell		Modell		Modell				
	3037		4037		5037		6037				
Leistung/Glied Watt	42,01		53,96		66,36		78,76				
Wasserin./Glied Liter	0,66		0,86		1,06		1,27				
Leergewicht/Glied kg	0,91		1,22		1,54		1,86				
Glieder	 Bau- länge [mm]	Watt	EUR	Watt	EUR	Watt	EUR	Watt	EUR	Watt	EUR
4	200			168	252,79	215	261,59	265	276,63	315	293,23
6	300			252	288,37	323	301,57	398	324,13	472	349,03
8	400			336	323,95	431	341,55	530	371,63	630	404,83
10	500			420	359,53	539	381,53	663	419,13	787	460,63
12	600			504	395,11	647	421,51	796	466,63	945	516,43
14	700			588	430,69	755	461,49	929	514,13	1102	572,23
16	800			672	466,27	863	501,47	1061	561,63	1260	628,03
18	900			756	501,85	971	541,45	1194	609,13	1417	683,83
20	1000			840	537,43	1079	581,43	1327	656,63	1575	739,63
22	1100			924	573,01	1187	621,41	1459	704,13	1732	795,43
24	1200			1008	608,59	1295	661,39	1592	751,63	1890	851,23
26	1300			1092	644,17	1402	701,37	1725	799,13	2047	907,03
28	1400			1176	679,75	1510	741,35	1858	846,63	2205	962,83
30	1500			1260	715,33	1618	781,33	1990	894,13	2362	1.018,63

NORM-WÄRMELEISTUNG (WATT) BEI 75/65/20 °C NACH EN 442, DIN REGISTRIERNUMMER 6R0900

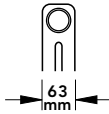
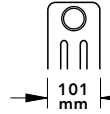
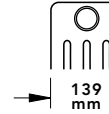
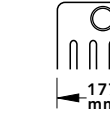
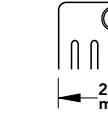
Die Preise verstehen sich ohne Befestigung.											
Bauhöhe [mm] 400	2-Säuler		3-Säuler		4-Säuler		5-Säuler		6-Säuler		
											
Nabenabstand 335 mm											
Modell	2040		3040		4040		5040		6040		
Leistung/Glied Watt	32,63		45,52		58,40		71,87		85,33		
Wasserin./Glied Liter	0,49		0,70		0,92		1,14		1,35		
Leergewicht/Glied kg	0,68		1,00		1,35		1,67		2,02		
Glieder	Bau- länge [mm]	Watt	EUR	Watt	EUR	Watt	EUR	Watt	EUR	Watt	EUR
4	200	130	247,35	182	253,95	233	262,75	287	277,55	341	295,55
6	300	195	280,21	273	290,11	350	303,31	431	325,51	511	352,51
8	400	261	313,07	364	326,27	467	343,87	574	373,47	682	409,47
10	500	326	345,93	455	362,43	584	384,43	718	421,43	853	466,43
12	600	391	378,79	546	398,59	700	424,99	862	469,39	1023	523,39
14	700	456	411,65	637	434,75	817	465,55	1006	517,35	1194	580,35
16	800	522	444,51	728	470,91	934	506,11	1149	565,31	1365	637,31
18	900	587	477,37	819	507,07	1051	546,67	1293	613,27	1535	694,27
20	1000	652	510,23	910	543,23	1168	587,23	1437	661,23	1706	751,23
22	1100	717	543,09	1001	579,39	1284	627,79	1581	709,19	1877	808,19
24	1200	783	575,95	1092	615,55	1401	668,35	1724	757,15	2047	865,15
26	1300	848	608,81	1183	651,71	1518	708,91	1868	805,11	2218	922,11
28	1400	913	641,67	1274	687,87	1635	749,47	2012	853,07	2389	979,07
30	1500	978	674,53	1365	724,03	1752	790,03	2156	901,03	2559	1.036,03

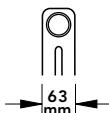
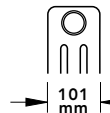
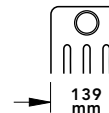
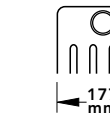
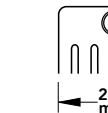
Die Preise verstehen sich ohne Befestigung.											
Bauhöhe [mm] 450	2-Säuler		3-Säuler		4-Säuler		5-Säuler		6-Säuler		
											
Nabenabstand 385 mm											
Modell	2045		3045		4045		5045		6045		
Leistung/Glied Watt	36,26		50,47		64,68		79,64		94,60		
Wasserin./Glied Liter	0,53		0,76		1,01		1,24		1,48		
Leergewicht/Glied kg	0,75		1,12		1,49		1,86		2,24		
Glieder	Bau- länge [mm]	Watt	EUR	Watt	EUR	Watt	EUR	Watt	EUR	Watt	EUR
4	200	145	249,15	201	257,67	258	266,03	318	281,51	378	297,19
6	300	217	282,91	302	295,69	388	308,23	477	331,45	567	354,97
8	400	290	316,67	403	333,71	517	350,43	637	381,39	756	412,75
10	500	362	350,43	504	371,73	646	392,63	796	431,33	946	470,53
12	600	435	384,19	605	409,75	776	434,83	955	481,27	1135	528,31
14	700	507	417,95	706	447,77	905	477,03	1114	531,21	1324	586,09
16	800	580	451,71	807	485,79	1034	519,23	1274	581,15	1513	643,87
18	900	652	485,47	908	523,81	1164	561,43	1433	631,09	1702	701,65
20	1000	725	519,23	1009	561,83	1293	603,63	1592	681,03	1892	759,43
22	1100	797	552,99	1110	599,85	1422	645,83	1752	730,97	2081	817,21
24	1200	870	586,75	1211	637,87	1552	688,03	1911	780,91	2270	874,99
26	1300	942	620,51	1312	675,89	1681	730,23	2070	830,85	2459	932,77
28	1400	1015	654,27	1413	713,91	1811	772,43	2229	880,79	2648	990,55
30	1500	1087	688,03	1514	751,93	1940	814,63	2389	930,73	2838	1.048,33

 LASERLINE
Mitte

LASERLINE VENTIL-MITTENANSCHLUSS

PREISE UND LEISTUNGEN

NORM-WÄRMELEISTUNG (WATT) BEI 75/65/20 °C NACH EN 442, DIN REGISTRIERNUMMER 6R0900

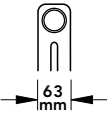
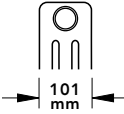
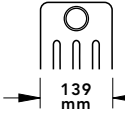
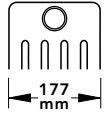
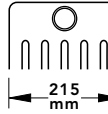
Die Preise verstehen sich ohne Befestigung.											
Bauhöhe [mm] 500	2-Säuler		3-Säuler		4-Säuler		5-Säuler		6-Säuler		
		63 mm		101 mm		139 mm		177 mm		215 mm	
Nabenabstand 435 mm											
Modell	2050		3050		4050		5050		6050		
Leistung/Glied Watt	39,87		55,38		70,88		87,32		103,76		
Wasserin./Glied Liter	0,57		0,83		1,09		1,34		1,60		
Leergewicht/Glied kg	0,83		1,23		1,64		2,04		2,46		
Glieder	Bau- länge [mm]	Watt	EUR	Watt	EUR	Watt	EUR	Watt	EUR	Watt	EUR
4	200	159	250,75	221	260,27	283	268,79	349	283,27	415	301,07
6	300	239	285,31	332	299,59	425	312,37	523	334,09	622	360,79
8	400	318	319,87	443	338,91	567	355,95	698	384,91	830	420,51
10	500	398	354,43	553	378,23	708	399,53	873	435,73	1037	480,23
12	600	478	388,99	664	417,55	850	443,11	1047	486,55	1245	539,95
14	700	558	423,55	775	456,87	992	486,69	1222	537,37	1452	599,67
16	800	637	458,11	886	496,19	1134	530,27	1397	588,19	1660	659,39
18	900	717	492,67	996	535,51	1275	573,85	1571	639,01	1867	719,11
20	1000	797	527,23	1107	574,83	1417	617,43	1746	689,83	2075	778,83
22	1100	877	561,79	1218	614,15	1559	661,01	1921	740,65	2282	838,55
24	1200	956	596,35	1329	653,47	1701	704,59	2095	791,47	2490	898,27
26	1300	1036	630,91	1439	692,79	1842	748,17	2270	842,29	2697	957,99
28	1400	1116	665,47	1550	732,11	1984	791,75	2444	893,11	2905	1.017,71
30	1500	1196	700,03	1661	771,43	2126	835,33	2619	943,93	3112	1.077,43

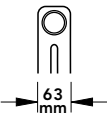
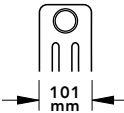
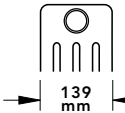
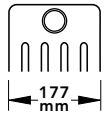
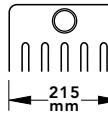
Die Preise verstehen sich ohne Befestigung.											
Bauhöhe [mm] 550	2-Säuler		3-Säuler		4-Säuler		5-Säuler		6-Säuler		
		63 mm		101 mm		139 mm		177 mm		215 mm	
Nabenabstand 485 mm											
Modell	2055		3055		4055		5055		6055		
Leistung/Glied Watt	43,46		60,25		77,03		94,93		112,83		
Wasserin./Glied Liter	0,62		0,89		1,17		1,45		1,73		
Leergewicht/Glied kg	0,91		1,34		1,79		2,23		2,68		
Glieder	Bau- länge [mm]	Watt	EUR	Watt	EUR	Watt	EUR	Watt	EUR	Watt	EUR
4	200	173	252,51	241	261,79	308	271,79	379	287,51	451	306,19
6	300	260	287,95	361	301,87	462	316,87	569	340,45	676	368,47
8	400	347	323,39	482	341,95	616	361,95	759	393,39	902	430,75
10	500	434	358,83	602	382,03	770	407,03	949	446,33	1128	493,03
12	600	521	394,27	723	422,11	924	452,11	1139	499,27	1353	555,31
14	700	608	429,71	843	462,19	1078	497,19	1329	552,21	1579	617,59
16	800	695	465,15	964	502,27	1232	542,27	1518	605,15	1805	679,87
18	900	782	500,59	1084	542,35	1386	587,35	1708	658,09	2030	742,15
20	1000	869	536,03	1205	582,43	1540	632,43	1898	711,03	2256	804,43
22	1100	956	571,47	1325	622,51	1694	677,51	2088	763,97	2482	866,71
24	1200	1043	606,91	1446	662,59	1848	722,59	2278	816,91	2707	928,99
26	1300	1129	642,35	1566	702,67	2002	767,67	2468	869,85	2933	991,27
28	1400	1216	677,79	1687	742,75	2156	812,75	2658	922,79	3159	1.053,55
30	1500	1303	713,23	1807	782,83	2310	857,83	2847	975,73	3384	1.115,83

NORM-WÄRMELEISTUNG (WATT) BEI 75/65/20 °C NACH EN 442, DIN REGISTRIERNUMMER 6R0900

Die Preise verstehen sich ohne Befestigung.

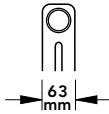
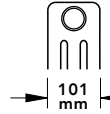
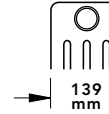
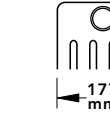
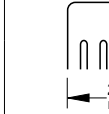
Bauhöhe [mm] 600		2-Säuler		3-Säuler		4-Säuler		5-Säuler		6-Säuler	
Nabenabstand 535 mm											
Modell		2060		3060		4060		5060		6060	
Leistung/Glied Watt		47,02		65,07		83,12		102,48		121,83	
Wasserin./Glied Liter		0,66		0,96		1,26		1,55		1,85	
Leergewicht/Glied kg		0,98		1,46		1,94		2,42		2,91	
Glieder	Bau- länge [mm]	Watt	EUR	Watt	EUR	Watt	EUR	Watt	EUR	Watt	EUR
4	200	188	254,27	260	264,23	332	275,75	409	291,71	487	311,35
6	300	282	290,59	390	305,53	498	322,81	614	346,75	730	376,21
8	400	376	326,91	520	346,83	664	369,87	819	401,79	974	441,07
10	500	470	363,23	650	388,13	831	416,93	1024	456,83	1218	505,93
12	600	564	399,55	780	429,43	997	463,99	1229	511,87	1461	570,79
14	700	658	435,87	910	470,73	1163	511,05	1434	566,91	1705	635,65
16	800	752	472,19	1041	512,03	1329	558,11	1639	621,95	1949	700,51
18	900	846	508,51	1171	553,33	1496	605,17	1844	676,99	2192	765,37
20	1000	940	544,83	1301	594,63	1662	652,23	2049	732,03	2436	830,23
22	1100	1034	581,15	1431	635,93	1828	699,29	2254	787,07	2680	895,09
24	1200	1128	617,47	1561	677,23	1994	746,35	2459	842,11	2923	959,95
26	1300	1222	653,79	1691	718,53	2161	793,41	2664	897,15	3167	1.024,81
28	1400	1316	690,11	1821	759,83	2327	840,47	2869	952,19	3411	1.089,67
30	1500	1410	726,43	1952	801,13	2493	887,53	3074	1.007,23	3654	1.154,53

Die Preise verstehen sich ohne Befestigung.

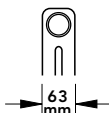
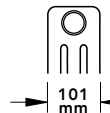
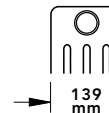
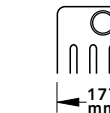
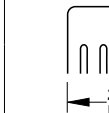

Bauhöhe [mm] 665		2-Säuler		3-Säuler		4-Säuler		5-Säuler		6-Säuler	
Nabenabstand 600 mm											
Modell		2067		3067		4067		5067		6067	
Leistung/Glied Watt		51,64		71,31		90,97		112,20		133,42	
Wasserin./Glied Liter		0,72		1,04		1,37		1,69		2,01	
Leergewicht/Glied kg		1,08		1,60		2,14		2,66		3,20	
Glieder	Bau- länge [mm]	Watt	EUR	Watt	EUR	Watt	EUR	Watt	EUR	Watt	EUR
4	200	206	256,15	285	268,11	363	287,19	448	308,31	533	326,39
6	300	309	293,41	427	311,35	545	339,97	673	371,65	800	398,77
8	400	413	330,67	570	354,59	727	392,75	897	434,99	1067	471,15
10	500	516	367,93	713	397,83	909	445,53	1122	498,33	1334	543,53
12	600	619	405,19	855	441,07	1091	498,31	1346	561,67	1601	615,91
14	700	722	442,45	998	484,31	1273	551,09	1570	625,01	1867	688,29
16	800	826	479,71	1140	527,55	1455	603,87	1795	688,35	2134	760,67
18	900	929	516,97	1283	570,79	1637	656,65	2019	751,69	2401	833,05
20	1000	1032	554,23	1426	614,03	1819	709,43	2244	815,03	2668	905,43
22	1100	1136	591,49	1568	657,27	2001	762,21	2468	878,37	2935	977,81
24	1200	1239	628,75	1711	700,51	2183	814,99	2692	941,71	3202	1.050,19
26	1300	1342	666,01	1854	743,75	2365	867,77	2917	1.005,05	3468	1.122,57
28	1400	1445	703,27	1996	786,99	2547	920,55	3141	1.068,39	3735	1.194,95
30	1500	1549	740,53	2139	830,23	2729	973,33	3366	1.131,73	4002	1.267,33



LASERLINE
Mitte

LASERLINE VENTIL-MITTENANSCHLUSS

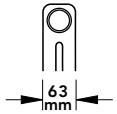
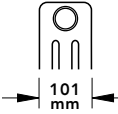
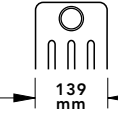
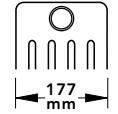
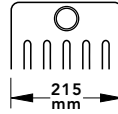
PREISE UND LEISTUNGEN

NORM-WÄRMELEISTUNG (WATT) BEI 75/65/20 °C NACH EN 442, DIN REGISTRIERNUMMER 6R0900

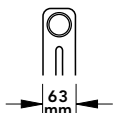
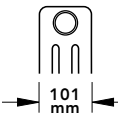
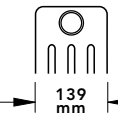
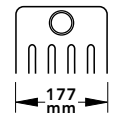
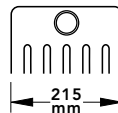
Die Preise verstehen sich ohne Befestigung.											
 Bauhöhe [mm] 750	2-Säuler		3-Säuler		4-Säuler		5-Säuler		6-Säuler		
											
 Nabenabstand 685 mm											
Modell	2075		3075		4075		5075		6075		
Leistung/Glied Watt	57,65		79,40		101,15		124,80		148,45		
Wasserin./Glied Liter	0,80		1,15		1,51		1,86		2,22		
Leergewicht/Glied kg	1,21		1,79		2,39		2,97		3,58		
Glieder	 Bau- länge [mm]	Watt	EUR	Watt	EUR	Watt	EUR	Watt	EUR	Watt	EUR
4	200	230	257,95	317	270,27	404	288,95	499	308,87	593	329,39
6	300	345	296,11	476	314,59	606	342,61	748	372,49	890	403,27
8	400	461	334,27	635	358,91	809	396,27	998	436,11	1187	477,15
10	500	576	372,43	794	403,23	1011	449,93	1248	499,73	1484	551,03
12	600	691	410,59	952	447,55	1213	503,59	1497	563,35	1781	624,91
14	700	807	448,75	1111	491,87	1416	557,25	1747	626,97	2078	698,79
16	800	922	486,91	1270	536,19	1618	610,91	1996	690,59	2375	772,67
18	900	1037	525,07	1429	580,51	1820	664,57	2246	754,21	2672	846,55
20	1000	1153	563,23	1588	624,83	2023	718,23	2496	817,83	2969	920,43
22	1100	1268	601,39	1746	669,15	2225	771,89	2745	881,45	3265	994,31
24	1200	1383	639,55	1905	713,47	2427	825,55	2995	945,07	3562	1.068,19
26	1300	1498	677,71	2064	757,79	2629	879,21	3244	1.008,69	3859	1.142,07
28	1400	1614	715,87	2223	802,11	2832	932,87	3494	1.072,31	4156	1.215,95
30	1500	1729	754,03	2382	846,43	3034	986,53	3744	1.135,93		

Die Preise verstehen sich ohne Befestigung.											
 Bauhöhe [mm] 900	2-Säuler		3-Säuler		4-Säuler		5-Säuler		6-Säuler		
											
 Nabenabstand 835 mm											
Modell	2090		3090		4090		5090		6090		
Leistung/Glied Watt	68,22		93,57		118,92		146,79		174,65		
Wasserin./Glied Liter	0,93		1,34		1,76		2,17		2,59		
Leergewicht/Glied kg	1,44		2,13		2,84		3,53		4,24		
Glieder	 Bau- länge [mm]	Watt	EUR	Watt	EUR	Watt	EUR	Watt	EUR	Watt	EUR
4	200	272	262,47	374	276,95	475	304,07	587	325,19	698	348,71
6	300	409	302,89	561	324,61	713	365,29	880	396,97	1047	432,25
8	400	545	343,31	748	372,27	951	426,51	1174	468,75	1397	515,79
10	500	682	383,73	935	419,93	1189	487,73	1467	540,53	1746	599,33
12	600	818	424,15	1122	467,59	1427	548,95	1761	612,31	2095	682,87
14	700	955	464,57	1309	515,25	1664	610,17	2055	684,09	2445	766,41
16	800	1091	504,99	1497	562,91	1902	671,39	2348	755,87	2794	849,95
18	900	1227	545,41	1684	610,57	2140	732,61	2642	827,65	3143	933,49
20	1000	1364	585,83	1871	658,23	2378	793,83	2935	899,43	3493	1.017,03
22	1100	1500	626,25	2058	705,89	2616	855,05	3229	971,21	3842	1.100,57
24	1200	1637	666,67	2245	753,55	2854	916,27	3522	1.042,99	4191	1.184,11
26	1300	1773	707,09	2432	801,21	3091	977,49	3816	1.114,77		
28	1400	1910	747,51	2619	848,87	3329	1.038,71				
30	1500	2046	787,93	2807	896,53	3567	1.099,93				

NORM-WÄRMELEISTUNG (WATT) BEI 75/65/20 °C NACH EN 442, DIN REGISTRIERNUMMER 6R0900

Die Preise verstehen sich ohne Befestigung.

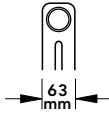
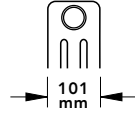
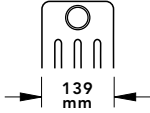
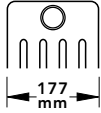
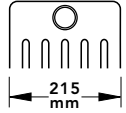
Bauhöhe [mm] 1000		2-Säuler		3-Säuler		4-Säuler		5-Säuler		6-Säuler	
Nabenabstand 935 mm											
Modell		2100		3100		4100		5100		6100	
Leistung/Glied Watt		75,26		102,97		130,67		161,31		191,95	
Wasserin./Glied Liter		1,02		1,47		1,93		2,38		2,84	
Leergewicht/Glied kg		1,59		2,36		3,14		3,91		4,69	
Glieder	Bau- länge [mm]	Watt	EUR	Watt	EUR	Watt	EUR	Watt	EUR	Watt	EUR
4	200	301	265,55	411	281,39	522	313,71	645	335,47	767	361,95
6	300	451	307,51	617	331,27	784	379,75	967	412,39	1151	452,11
8	400	602	349,47	823	381,15	1045	445,79	1290	489,31	1535	542,27
10	500	752	391,43	1029	431,03	1306	511,83	1613	566,23	1919	632,43
12	600	903	433,39	1235	480,91	1568	577,87	1935	643,15	2303	722,59
14	700	1053	475,35	1441	530,79	1829	643,91	2258	720,07	2687	812,75
16	800	1204	517,31	1647	580,67	2090	709,95	2580	796,99	3071	902,91
18	900	1354	559,27	1853	630,55	2352	775,99	2903	873,91	3455	993,07
20	1000	1505	601,23	2059	680,43	2613	842,03	3226	950,83	3839	1.083,23
22	1100	1655	643,19	2265	730,31	2874	908,07	3548	1.027,75	4222	1.173,39
24	1200	1806	685,15	2471	780,19	3136	974,11	3871	1.104,67		
26	1300	1956	727,11	2677	830,07	3397	1.040,15	4194	1.181,59		
28	1400	2107	769,07	2883	879,95	3658	1.106,19				
30	1500	2257	811,03	3089	929,83	3920	1.172,23				

Die Preise verstehen sich ohne Befestigung.

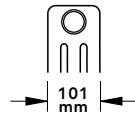
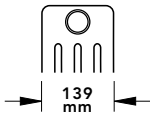
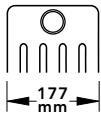
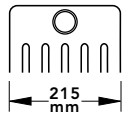



Bauhöhe [mm] 1065		3-Säuler		4-Säuler		5-Säuler		6-Säuler			
Nabenabstand 1000 mm											
Modell		3107		4107		5107		6107			
Leistung/Glied Watt		109,07		138,29		170,72		203,15			
Wasserin./Glied Liter		1,55		2,04		2,52		3,00			
Leergewicht/Glied kg		2,46		3,24		4,15		4,98			
Glieder	Bau- länge [mm]	Watt	EUR	Watt	EUR	Watt	EUR	Watt	EUR		
4	200			436	293,23	553	328,55	682	354,99	812	386,67
6	300			654	349,03	829	402,01	1024	441,67	1218	489,19
8	400			872	404,83	1106	475,47	1365	528,35	1625	591,71
10	500			1090	460,63	1382	548,93	1707	615,03	2031	694,23
12	600			1308	516,43	1659	622,39	2048	701,71	2437	796,75
14	700			1526	572,23	1936	695,85	2390	788,39	2844	899,27
16	800			1745	628,03	2212	769,31	2731	875,07	3250	1.001,79
18	900			1963	683,83	2489	842,77	3072	961,75	3656	1.104,31
20	1000										



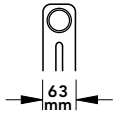
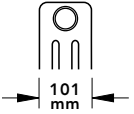
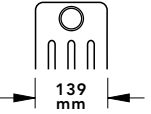
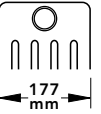
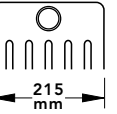

LASERLINE
Mitte

LASERLINE VENTIL-MITTENANSCHLUSS



PREISE UND LEISTUNGEN

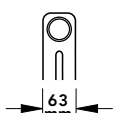
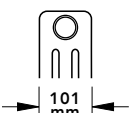
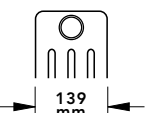
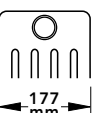
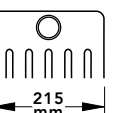

NORM-WÄRMELEISTUNG (WATT) BEI 75/65/20 °C NACH EN 442, DIN REGISTRIERNUMMER 6R0900

Die Preise verstehen sich ohne Befestigung.											
 Bauhöhe [mm] 1100	2-Säuler		3-Säuler		4-Säuler		5-Säuler		6-Säuler		
	 Nabenabstand 1035 mm										
Modell	2110		3110		4110		5110		6110		
Leistung/Glied Watt	82,30		112,34		142,38		175,77		209,16		
Wasserin./Glied Liter	1,11		1,60		2,10		2,59		3,10		
Leergewicht/Glied kg	1,75		2,59		3,44		4,28		5,14		
Glieder	 Bau- länge [mm]	Watt	EUR	Watt	EUR	Watt	EUR	Watt	EUR	Watt	EUR
4	200	329	271,51	449	296,27	569	331,47	703	361,95	836	393,87
6	300	493	316,45	674	353,59	854	406,39	1054	452,11	1254	499,99
8	400	658	361,39	898	410,91	1139	481,31	1406	542,27	1673	606,11
10	500	823	406,33	1123	468,23	1423	556,23	1757	632,43	2091	712,23
12	600	987	451,27	1348	525,55	1708	631,15	2109	722,59	2509	818,35
14	700	1152	496,21	1572	582,87	1993	706,07	2460	812,75	2928	924,47
16	800	1316	541,15	1797	640,19	2278	780,99	2812	902,91	3346	1.030,59
18	900	1481	586,09	2022	697,51	2562	855,91	3163	993,07	3764	1.136,71
20	1000										

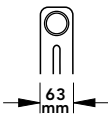
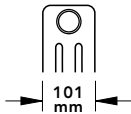
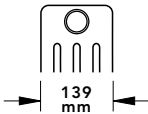
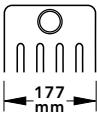
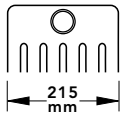
Die Preise verstehen sich ohne Befestigung.											
 Bauhöhe [mm] 1200	2-Säuler		3-Säuler		4-Säuler		5-Säuler		6-Säuler		
	 Nabenabstand 1135 mm										
Modell	2120		3120		4120		5120		6120		
Leistung/Glied Watt	89,35		121,70		154,04		190,17		226,29		
Wasserin./Glied Liter	1,19		1,73		2,27		2,80		3,33		
Leergewicht/Glied kg	1,90		2,81		3,74		4,65		5,58		
Glieder	 Bau- länge [mm]	Watt	EUR	Watt	EUR	Watt	EUR	Watt	EUR	Watt	EUR
4	200	357	279,35	486	313,63	616	347,79	760	387,27	905	421,63
6	300	536	328,21	730	379,63	924	430,87	1141	490,09	1357	541,63
8	400	714	377,07	973	445,63	1232	513,95	1521	592,91	1810	661,63
10	500	893	425,93	1217	511,63	1540	597,03	1901	695,73	2262	781,63
12	600	1072	474,79	1460	577,63	1848	680,11	2282	798,55	2715	901,63
14	700	1250	523,65	1703	643,63	2156	763,19	2662	901,37	3168	1.021,63
16	800	1429	572,51	1947	709,63	2464	846,27	3042	1.004,19	3620	1.141,63
18	900	1608	621,37	2190	775,63	2772	929,35	3423	1.107,01	4073	1.261,63
20	1000										

NORM-WÄRMELEISTUNG (WATT) BEI 75/65/20 °C NACH EN 442, DIN REGISTRIENUMMER 6R0900

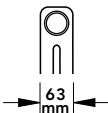
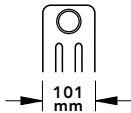
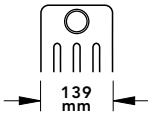
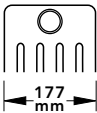
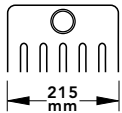

Die Preise verstehen sich ohne Befestigung.											
 Bauhöhe [mm] 1500	2-Säuler		3-Säuler		4-Säuler		5-Säuler		6-Säuler		
											
 Nababstand 1435 mm											
Modell	2150		3150		4150		5150		6150		
Leistung/Glied Watt	110,64		149,80		188,95		233,18		277,41		
Wasserin./Glied Liter	1,46		2,11		2,77		3,42		4,08		
Leergewicht/Glied kg	2,36		3,49		4,64		5,77		6,92		
Glieder	 Bau- länge [mm]	Watt	EUR	Watt	EUR	Watt	EUR	Watt	EUR	Watt	EUR
4	200	442	305,87	599	353,19	755	405,67	932	458,47	1109	512,19
6	300	663	367,99	898	438,97	1133	517,69	1399	596,89	1664	677,47
8	400	885	430,11	1198	524,75	1511	629,71	1865	735,31	2219	842,75
10	500	1106	492,23	1498	610,53	1889	741,73	2331	873,73	2774	1.008,03
12	600	1327	554,35	1797	696,31	2267	853,75	2798	1.012,15	3328	1.173,31
14	700	1548	616,47	2097	782,09	2645	965,77	3264	1.150,57	3883	1.338,59
16	800	1770	678,59	2396	867,87	3023	1.077,79	3730	1.288,99		
18	900	1991	740,71	2696	953,65	3401	1.189,81	4197	1.427,41		
20	1000										



Die Preise verstehen sich ohne Befestigung.											
 Bauhöhe [mm] 1800	2-Säuler		3-Säuler		4-Säuler		5-Säuler		6-Säuler		
											
 Nababstand 1735 mm											
Modell	2180		3180		4180		5180		6180		
Leistung/Glied Watt	132,23		178,08		223,92		276,14		328,35		
Wasserin./Glied Liter	1,72		2,49		3,27		4,04		4,82		
Leergewicht/Glied kg	2,82		4,17		5,53		6,88		8,25		
Glieder	 Bau- länge [mm]	Watt	EUR	Watt	EUR	Watt	EUR	Watt	EUR	Watt	EUR
4	200	528	325,75	712	392,75	895	450,87	1104	510,55	1313	572,79
6	300	793	397,81	1068	498,31	1343	585,49	1656	675,01	1970	768,37
8	400	1057	469,87	1424	603,87	1791	720,11	2209	839,47	2626	963,95
10	500	1322	541,93	1780	709,43	2239	854,73	2761	1.003,93	3283	1.159,53
12	600	1586	613,99	2136	814,99	2687	989,35	3313	1.168,39	3940	1.355,11
14	700	1851	686,05	2493	920,55	3134	1.123,97	3865	1.332,85		
16	800	2115	758,11	2849	1.026,11	3582	1.258,59	4418	1.497,31		
18	900	2380	830,17	3205	1.131,67	4030	1.393,21				
20	1000										

 LASERLINE
Mitte

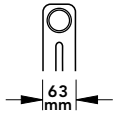
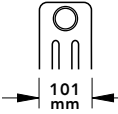
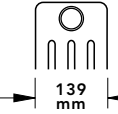
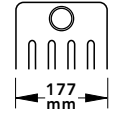
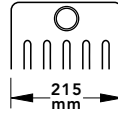
LASERLINE VENTIL-MITTENANSCHLUSS

PREISE UND LEISTUNGEN

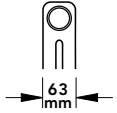
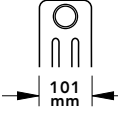
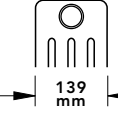
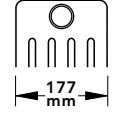
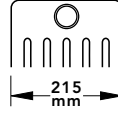
NORM-WÄRMELEISTUNG (WATT) BEI 75/65/20 °C NACH EN 442, DIN REGISTRIERNUMMER 6R0900											
Die Preise verstehen sich ohne Befestigung.											
 Bauhöhe [mm] 2000	2-Säuler		3-Säuler		4-Säuler		5-Säuler		6-Säuler		
											
 Nabenabstand 1935 mm											
Modell	2200		3200		4200		5200		6200		
Leistung/Glied Watt	146,83		197,10		247,36		304,85		362,34		
Wasserin./Glied Liter	1,90		2,75		3,61		4,46		5,31		
Leergewicht/Glied kg	3,12		4,62		6,13		7,63		9,15		
Glieder	 Bau- länge [mm]	Watt	EUR	Watt	EUR	Watt	EUR	Watt	EUR	Watt	EUR
4	200	587	342,63	788	408,43	989	478,95	1219	549,19	1449	616,47
6	300	880	423,13	1182	521,83	1484	627,61	1829	732,97	2174	833,89
8	400	1174	503,63	1576	635,23	1978	776,27	2438	916,75	2898	1.051,31
10	500	1468	584,13	1971	748,63	2473	924,93	3048	1.100,53	3623	1.268,73
12	600	1761	664,63	2365	862,03	2968	1.073,59	3658	1.284,31		
14	700	2055	745,13	2759	975,43	3463	1.222,25	4267	1.468,09		
16	800	2349	825,63	3153	1.088,83	3957	1.370,91				
18	900	2642	906,13	3547	1.202,23	4452	1.519,57				
20	1000										

Die Preise verstehen sich ohne Befestigung.											
 Bauhöhe [mm] 2200	2-Säuler		3-Säuler		4-Säuler		5-Säuler		6-Säuler		
											
 Nabenabstand 2135 mm											
Modell	2220		3220		4220		5220		6220		
Leistung/Glied Watt	161,63		216,28		270,93		333,68		396,42		
Wasserin./Glied Liter	2,08		3,01		3,94		4,87		5,81		
Leergewicht/Glied kg	3,43		5,07		6,73		8,38		10,04		
Glieder	 Bau- länge [mm]	Watt	EUR	Watt	EUR	Watt	EUR	Watt	EUR	Watt	EUR
4	200	646	362,55	865	437,99	1083	513,35	1334	588,75	1585	661,15
6	300	969	453,01	1297	566,17	1625	679,21	2002	792,31	2378	900,91
8	400	1293	543,47	1730	694,35	2167	845,07	2669	995,87	3171	1.140,67
10	500	1616	633,93	2162	822,53	2709	1.010,93	3336	1.199,43	3964	1.380,43
12	600	1939	724,39	2595	950,71	3251	1.176,79	4004	1.402,99		
14	700	2262	814,85	3027	1.078,89	3793	1.342,65				
16	800	2586	905,31	3460	1.207,07	4334	1.508,51				
18	900	2909	995,77	3893	1.335,25						
20	1000										





NORM-WÄRMELEISTUNG (WATT) BEI 75/65/20 °C NACH EN 442, DIN REGISTRIERNUMMER 6R0900

Die Preise verstehen sich ohne Befestigung.											
Bauhöhe [mm] 2500		2-Säuler		3-Säuler		4-Säuler		5-Säuler		6-Säuler	
Nabenabstand 2435 mm											
Modell		2250		3250		4250		5250		6250	
Leistung/Glied Watt		184,23		245,44		306,30		377,21		447,78	
Wasserin./Glied Liter		2,34		3,39		4,45		5,50		6,55	
Leergewicht/Glied kg		3,89		5,75		7,63		9,49		11,37	
Glieder	Bau- länge [mm]	Watt	EUR	Watt	EUR	Watt	EUR	Watt	EUR	Watt	EUR
4	200	736	385,19	981	471,99	1225	555,47	1508	638,71	1791	725,59
6	300	1105	486,97	1472	617,17	1838	742,39	2263	867,25	2686	997,57
8	400	1473	588,75	1963	762,35	2450	929,31	3017	1.095,79	3582	1.269,55
10	500	1842	690,53	2454	907,53	3063	1.116,23	3772	1.324,33		
12	600	2210	792,31	2945	1.052,71	3676	1.303,15				
14	700	2579	894,09	3436	1.197,89	4288	1.490,07				
16	800	2947	995,87	3927	1.343,07						
18	900										
20	1000										

Die Preise verstehen sich ohne Befestigung.											
Bauhöhe [mm] 2800		2-Säuler		3-Säuler		4-Säuler		5-Säuler		6-Säuler	
Nabenabstand 2735 mm											
Modell		2280		3280		4280		5280		6280	
Leistung/Glied Watt		207,36		275,09		342,82		421,18		499,53	
Wasserin./Glied Liter		2,61		3,78		4,95		6,12		7,29	
Leergewicht/Glied kg		4,34		6,43		8,53		10,61		12,71	
Glieder	Bau- länge [mm]	Watt	EUR	Watt	EUR	Watt	EUR	Watt	EUR	Watt	EUR
4	200	829	404,79	1100	507,55	1371	604,43	1684	688,91	1998	791,63
6	300	1244	516,37	1650	670,51	2056	815,83	2527	942,55	2997	1.096,63
8	400	1658	627,95	2200	833,47	2742	1.027,23	3369	1.196,19	3996	1.401,63
10	500	2073	739,53	2750	996,43	3428	1.238,63	4211	1.449,83		
12	600	2488	851,11	3301	1.159,39	4113	1.450,03				
14	700	2903	962,69	3851	1.322,35						
16	800	3317	1.074,27	4401	1.485,31						
18	900										
20	1000										

LASERLINE
Mitte

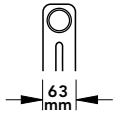
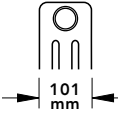
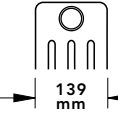
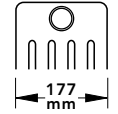
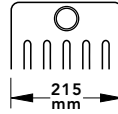
NORM-WÄRMELEISTUNG (WATT) BEI 75/65/20 °C NACH EN 442, DIN REGISTRIERNUMMER 6R0900

Die Preise verstehen sich ohne Befestigung.											
 Bauhöhe [mm] 3000	2-Säuler		3-Säuler		4-Säuler		5-Säuler		6-Säuler		
	 Nabenabstand 2935 mm		 63 mm		 101 mm		 139 mm		 177 mm		 215 mm
Modell	2300		3300		4300		5300		6300		
Leistung/Glied Watt	223,10		295,18		367,25		450,78		534,30		
Wasserin./Glied Liter	2,79		4,03		5,29		6,53		7,79		
Leergewicht/Glied kg	4,65		6,88		9,12		11,35		13,60		
Glieder	 Bau- länge [mm]	Watt	EUR	Watt	EUR	Watt	EUR	Watt	EUR	Watt	EUR
4	200	892	416,87	1180	531,47	1469	630,91	1803	724,39	2137	829,87
6	300	1338	534,49	1771	706,39	2203	855,55	2704	995,77	3205	1.153,99
8	400	1784	652,11	2361	881,31	2938	1.080,19	3606	1.267,15	4274	1.478,11
10	500	2231	769,73	2951	1.056,23	3672	1.304,83				
12	600	2677	887,35	3542	1.231,15						
14	700	3123	1.004,97	4132	1.406,07						
16	800	3569	1.122,59	4722	1.580,99						
18	900										
20	1000										

PREISE

Mehrpreise Sonderausführungen	Preis in EUR oder Mehrpreis in %
RAL-Farbtöne außer RAL 9016	30 %
Sanitärfarbtöne und Spezialfarben	30 %
Angeschweißte Haltetaschen pro Stück	15,09
Sonderbauhöhen zwischen 300 und 3000 mm (gewünschter Nabenabstand in mm + 65 mm = Gesamtbauhöhe)	Preis von nächster Standardhöhe
Ausführung mit Erdungslasche	44,52
Lieferbar auch als Ventil-Seitenanschluss (links oder rechts)	Preis Ventil-Mittenanschluss

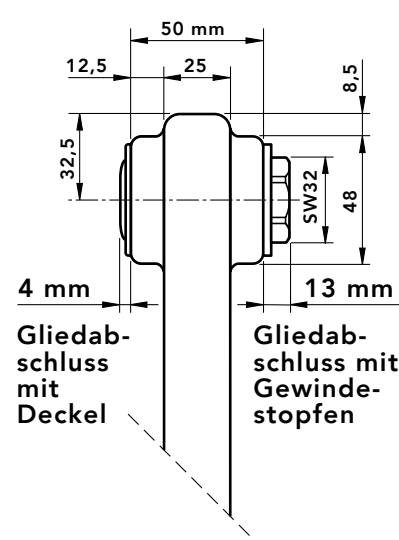

Hinweis: Der Differenzbetrag von Standard Röhrenradiator auf Ventil-Mittenanschluss beträgt 181,63 EUR



LASERLINE
TWIN

LASERLINE TWIN

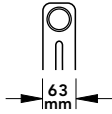
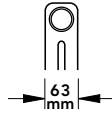
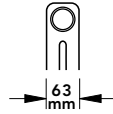
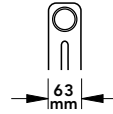
* NORM-WÄRMELEISTUNG NACH EN 442 WATT, DIN REGISTRIENUMMER 6R0900						
↑ Bauhöhe [mm]		1000	1200	1500	1800	
		2-Säuler 	2-Säuler 	2-Säuler 	2-Säuler 	
Modell		2100	2120	2150	2180	
Glieder	↔ Bau- länge [mm]					
10	500	Watt 75/65/20° *	753	893	1106	1322
		Wasserinhalt Liter	10,20	11,90	14,60	17,20
		Leergewicht kg	15,90	19,00	23,60	28,20
		Heizkörperexponent n	1,27	1,28	1,30	1,32
		Preis EUR	718,43	753,09	819,41	869,18
12	600	Watt 75/65/20° *	904	1072	1328	1587
		Wasserinhalt Liter	12,20	14,30	17,50	20,60
		Leergewicht kg	19,10	22,80	28,30	33,80
		Heizkörperexponent n	1,27	1,28	1,30	1,32
		Preis EUR	759,89	801,33	881,24	940,80

SONDERAUSFÜHRUNG / PREISE

Mehrpriese Sonderausführungen	Artikelnummer	Preis in EUR oder Mehrpreis in %
RAL-Farbtöne ausser RAL 9016		30 %
Sanitärfarbtöne und Spezialfarben		30 %
Anschluss nach unten für Elektroheizpatrone		23,37
PTC-Heizpatrone*, 750 Watt, mit Schukostecker und Schalter, Einbautiefe 535 mm	Z13EH0048002730	158,31
PTC-Heizpatrone*, 900 Watt, mit Schukostecker und Schalter, Einbautiefe 620 mm (nicht geeignet für Model 2100/10 Glieder)	Z13EH0048002930	162,08



1 

ULOW-E2

Profil-
heizkörper

Plan-
heizkörper

Vertikal-
heizkörper

Zubehör

2 

Noppen-
system

Klettsystem

Tacker-
system

Verlegeschie-
nensystem

Gittermatten-
system

Trocken-
system

Zubehör

3 

Bad-
heizkörper

Design-
heizkörper

Elektro-
heizkörper

4 

LASERLINE
Standard

LASERLINE
Mitte

LASERLINE
Architecture

LASERLINE ARCHITECTURE WÄRME-THEKE

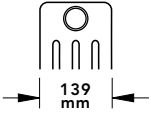
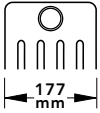
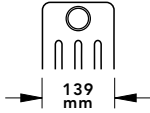
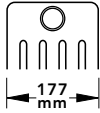
TECHNIK / PREISE / EIGENE RABATTGRUPPE!						
↕ Wärme-Theke Bauhöhe [mm]		940		1090		
Radiator Bauhöhe [mm]		750		900		
→ Wärme-Theke Bautiefe [mm]		224	262	224	262	
Radiator Bautiefe						
Modell		4075	5075	4090	5090	
Glieder	↔ Bau-länge [mm]					
14	720 (700)*	Watt 75/65/20° **	1417	1747	1665	2055
		Wasserinhalt Liter	21,2	26,1	24,7	30,4
		Leergewicht kg	50	58	58	68
		Heizkörperexponent n	1,30	1,30	1,31	1,31
		Preis EUR	1.358,40	1.408,89	1.424,76	1.487,32
18	920 (900)*	Watt 75/65/20° **	1822	2246	2140	2642
		Wasserinhalt Liter	27,2	33,5	31,7	39,1
		Leergewicht kg	59	70	69	82
		Heizkörperexponent n	1,30	1,30	1,31	1,31
		Preis EUR	1.471,48	1.537,84	1.555,92	1.638,08
22	1120 (1100)*	Watt 75/65/20° **	2226	2746	2616	3230
		Wasserinhalt Liter	33,3	41,0	38,8	47,8
		Leergewicht kg	69	82	81	97
		Heizkörperexponent n	1,30	1,30	1,31	1,31
		Preis EUR	1.584,58	1.666,74	1.687,47	1.788,85

* Bauhöhe Radiator
** Norm-Wärmeleistung nach EN 442 Watt, DIN Registriernummer 6R0900

Auflage (Buche Multiplex) für Wärme-Theke	Abmessungen Auflage	für Modell	Artikelnummer	Gewicht in kg	Preis in EUR
	1150 x 350 x 35	4075 und 4090 in BL 700 mm	Z13DZ8340901400	~9	947,29
	1350 x 350 x 35	4075 und 4090 in BL 900 mm	Z13DZ8340901800	~10	973,67
	1550 x 350 x 35	4075 und 4090 in BL 1100 mm	Z13DZ8340902200	~11	1.000,06
	1150 x 400 x 35	5075 und 5090 in BL 700 mm	Z13DZ8350901400	~10	1.010,29
	1350 x 400 x 35	5075 und 5090 in BL 900 mm	Z13DZ8350901800	~11	1.058,27
	1550 x 400 x 35	5075 und 5090 in BL 1100 mm	Z13DZ8350902200	~12	1.106,51





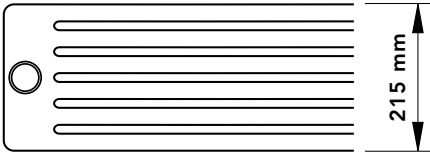

LASERLINE ARCHITECTURE WÄRME-BANK

LASERLINE
WÄRME-BANK

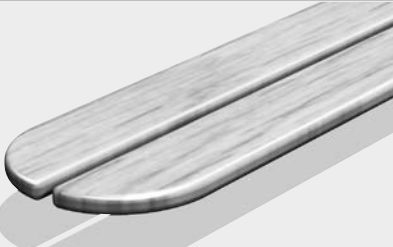
TECHNIK / PREISE / EIGENE RABATTGRUPPE!							
↔ Wärme-Bank Baulänge [mm]			1850	2150	2350	2850	3150
Radiator Baulänge [mm]			1500	1800	2000	2500	2800
➔ Wärme-Bank Bautiefe [mm]			370				
Radiator Bautiefe			6-Säuler 				
Modell			6150	6180	6200	6250	6280
Glieder	↕ Bauhöhe [mm]						
4	422 (200)*	Watt 75/65/20° **	1411	1696	1886	2362	2648
		Wasserinhalt Liter	16,4	19,3	21,3	26,2	29,2
		Leergewicht kg	37,5	42,8	46,4	55,3	64,2
		Heizkörperexponent n	1,32	1,31	1,31	1,30	1,29
		Preis EUR	1.201,49	1.275,26	1.323,97	1.735,34	1.806,41
5	472 (250)*	Watt 75/65/20° **	1742	2097	2334	2929	3287
		Wasserinhalt Liter	20,4	24,1	26,6	32,8	36,5
		Leergewicht kg	45,2	51,9	56,4	67,5	78,6
		Heizkörperexponent n	1,28	1,28	1,28	1,29	1,29
		Preis EUR	1.303,04	1.396,83	1.457,53	1.898,48	1.988,68
6	522 (300)*	Watt 75/65/20° **	1934	2337	2606	3285	3695
		Wasserinhalt Liter	24,5	29,0	31,9	39,3	43,8
		Leergewicht kg	52,9	60,9	66,3	79,6	93
		Heizkörperexponent n	1,29	1,28	1,28	1,28	1,28
		Preis EUR	1.405,46	1.516,58	1.590,35	2.062,44	2.169,28
7	572 (350)*	Watt 75/65/20° **	2204	2670	2982	3770	4247
		Wasserinhalt Liter	28,6	33,8	37,2	45,9	51,1
		Leergewicht kg	60,6	70,0	76,3	91,8	107,4
		Heizkörperexponent n	1,29	1,29	1,30	1,31	1,32
		Preis EUR	1.507,08	1.637,20	1.722,29	2.225,72	2.349,76

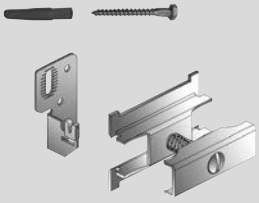
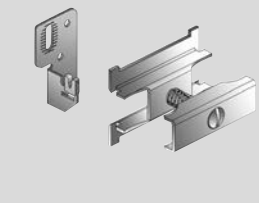
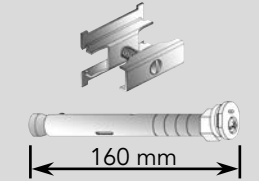
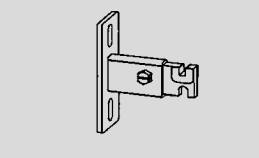
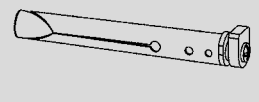

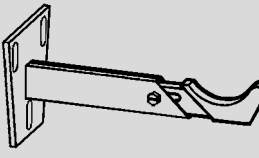
* Bauhöhe Radiator
** Norm-Wärmeleistung nach EN 442 Watt, DIN Registriernummer 6R0900

Auflage Wärme-Bank	687,48	691,26	704,08	728,95	766,63
Artikelnummer	Z13DZ8361500000	Z13DZ8361800000	Z13DZ8362000000	Z13DZ8362500000	Z13DZ8362800000
Gewicht in kg	~23	~26	~29	~34	~38
	Auflage für Wärme-Bank (Buche Multiplex) <ul style="list-style-type: none"> aus verleimtem Buchenholz (Multiplex) ca. 35 mm dick allseitig gerundet, zweiteilig, ab Baulänge 2850 mm vierteilig Oberfläche Buche funiert mit DD-Lack farblos, seidenmatt, zweimal lackiert, spritzwasserfest vorbereitet zur einfachen Montage auf Architecture- Aufstellkonsole, notwendiges Befestigungsmaterial beigelegt 				

ZUBEHÖR			
Abbildung	Artikelbezeichnung	Bestell-Nr.	Preis EUR
	Anschluss-Sets mit Winkelkonsole für Radiatoren ohne Befestigungslaschen		
	bestehend aus je 4 Radiatorenhaltern und Winkelkonsolen mit Schallschutzeinlagen, Schrauben und Dübeln sowie einer Montageanleitung: Anschluss-Set 1 (4er), Wandabstand 32 und 42 mm - RAL 9016 Anschluss-Set 1 (4er), Wandabstand 32 und 42 mm - andere Farbtöne	Z13DZ9522231000 Z13DZ952233100R	17,94 35,87
	bestehend aus je 6 Radiatorenhaltern und Winkelkonsolen mit Schallschutzeinlagen, Schrauben und Dübeln sowie einer Montageanleitung Anschluss-Set 2 (6er), Wandabstand 32 und 42 mm - RAL 9016 Anschluss-Set 2 (6er), Wandabstand 32 und 42 mm - andere Farbtöne	Z13DZ9522232000 Z13DZ952233200R	24,33 48,65
	Anschluss-Sets mit Bohrkonsole für Radiatoren ohne Befestigungslaschen bestehend aus 4 Radiatorenhaltern (RAL 9016) und 4 Bohrkonsolen sowie einer Montageanleitung		
	Anschluss-Set 3 (4er) Anschluss-Set 4 (6er)	Z13DZ9522233000 Z13DZ952234000	20,53 28,51
	Wandkonsole RK zum Anschrauben an die Wand, schallgedämmt, Wandabstand verstellbar		pro Stk.
	für Wandabstände von 35 bis 42 mm (RK 1) RAL 9016 für Wandabstände von 35 bis 42 mm (RK 1) andere Farbtöne für Wandabstände von 42 bis 58 mm (RK 2) RAL 9016 für Wandabstände von 42 bis 58 mm (RK 2) andere Farbtöne	Z13DZ9501557000 Z13DZ950155500R Z13DZ9501558000 Z13DZ950155600R	10,18 14,25 10,68 15,03
	Spannbohrkonsole RA Spreizdübel mit Doppelkeil zum Einbau in die Wand, verzinkt, schallgedämmt, empfohlener Bohrdurchmesser 18mm		pro Stk.
	Länge 160 mm Länge 200 mm	Z13DZ9501403000 Z13DZ9501404000	3,76 4,19
	Radiatorenhalter „RH 2“ zur Verwendung mit allen vorstehenden Wandkonsolen, seiten- und höhenverstellbar, Radiatorenhalter sind an oberster Lage an der Rückseite des Radiators zu montieren!		pro Stk.
	Radiatorenhalter - RAL 9016 Radiatorenhalter - andere Farbtöne	Z13DZ9501310000 Z13DZ950131100R	4,48 6,67
	Regulier-Wandkonsole RV zum Anschrauben an die Wand, schallgedämmt, Wandabstand verstellbar, empfohlene Modelle fett gedruckt;		pro Stk.
	RV1 Länge 70 bis 92 mm; für 2-Säuler (Wandabstand 39 bis 60 mm) und 3-Säuler (Wandabstand 20 bis 41 mm) - RAL 9016 wie vor - jedoch andere Farbtöne	Z13DZ9521634000 Z13DZ952153700R	10,13 14,14
	RV2 Länge 90 bis 140 mm; für 2-Säuler (Wandabstand 59 bis 108 mm), 3-Säuler (Wandabstand 40 bis 89 mm) , 4-Säuler (Wandabstand 21 bis 70 mm) und 5-Säuler (Wandabstand 15 bis 51 mm) - RAL 9016 wie vor - jedoch andere Farbtöne	Z13DZ9521635000 Z13DZ952153800R	11,02 15,48
	RV3 Länge 130 bis 210 mm; für 4-Säuler (Wandabstand 61 bis 140 mm), 5-Säuler (Wandabstand 42 - 121 mm) und 6-Säuler (Wandabstand 23 - 102 mm) - RAL 9016 wie vor - jedoch andere Farbtöne	Z13DZ9521636000 Z13DZ952153900R	11,27 15,80
	Abstandhalter „AH2“ hält unteren Wandabstand bei Wandbefestigung, übernimmt keine tragende Funktion, Wandabstand verstellbar (40 - 60 mm), Klemmteil und Wandteller Kunststoff transparent	Z13DZ9501604000	pro Stk. 5,14

Zubehör

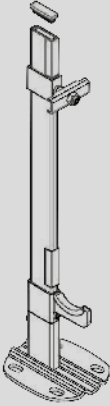
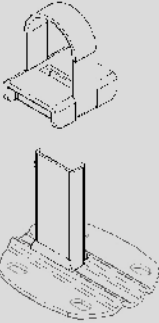
Die Befestigungspunkte der Aufhängungen finden Sie in der Technik auf den Seiten 262 bis 264. Für Standkonsolen gelten die halben Befestigungspunkte.

ZUBEHÖR			
Abbildung	Artikelbezeichnung	Bestell-Nr.	Preis EUR
	Klemhalter „KH“ hält unteren Wandabstand bei Wandbefestigung, übernimmt keine tragende Funktion, Wandabstand von 35 bis 50 mm verstellbar, Klemmteil (Kunststoff weiß) mit Gewinde und Dübel	Z13DZ9521306000	pro Stk. 5,27
	Standkonsole SK2 fertiglackiert, für freistehende LaserLine Röhrenradiatoren bis 1000 mm Bauhöhe bestehend aus: Fußplatte 3 mm dick zum Anschrauben auf Roh- (Aufbauhöhe FFB bei Modellauswahl berücksichtigen) oder Fertigfußboden, zur Aufnahme des Standrohres, Standrohr 35 x 10 x 1,5 mm, Befestigungssatz mit Konsole, Distanzhülse und Feststellschraube (verzinkt), höhen- und tiefenverstellbar, Endstopfen Kunststoff weiß für Standrohr oben und Schraubenkappe weiß. Für BH 300 mm (L = 460 mm) > RAL 9016 Für BH 300 mm (L = 460 mm) > andere Farbtöne Für BH 350 mm (L = 510 mm) > RAL 9016 Für BH 350 mm (L = 510 mm) > andere Farbtöne Für BH 400 mm (L = 560 mm) > RAL 9016 Für BH 400 mm (L = 560 mm) > andere Farbtöne Für BH 450 mm (L = 610 mm) > RAL 9016 Für BH 450 mm (L = 610 mm) > andere Farbtöne Für BH 500 mm (L = 660 mm) > RAL 9016 Für BH 500 mm (L = 660 mm) > andere Farbtöne Für BH 550 mm (L = 710 mm) > RAL 9016 Für BH 550 mm (L = 710 mm) > andere Farbtöne Für BH 600 mm (L = 760 mm) > RAL 9016 Für BH 600 mm (L = 760 mm) > andere Farbtöne Für BH 750 mm (L = 910 mm) > RAL 9016 Für BH 750 mm (L = 910 mm) > andere Farbtöne Für BH 900 mm (L = 1060 mm) > RAL 9016 Für BH 900 mm (L = 1060 mm) > andere Farbtöne Für BH 1000 mm (L = 1160 mm) > RAL 9016 Für BH 1000 mm (L = 1160 mm) > andere Farbtöne	Z13DZ9522404600 Z13DZ952250460R Z13DZ9522405100 Z13DZ952250510R Z13DZ9522405600 Z13DZ952250560R Z13DZ9522406100 Z13DZ952250610R Z13DZ9522406600 Z13DZ952250660R Z13DZ9522407100 Z13DZ952250710R Z13DZ9522407600 Z13DZ952250760R Z13DZ9522409100 Z13DZ952250910R Z13DZ9522410600 Z13DZ952251060R Z13DZ9522411600 Z13DZ952251160R	pro Stk. 30,63 39,82 31,30 40,69 31,70 41,22 32,11 41,75 32,40 42,11 32,52 42,28 33,06 42,97 34,15 44,41 35,65 46,34 36,73 47,75
	Ringanker-Fußkonsole FK5 fertiglackiert, für freistehende LaserLine Röhrenradiatoren bis 500 mm Bauhöhe, bestehend aus Fußplatte 3 mm dick zum Anschrauben auf Roh- oder Fertigfußboden, zur Aufnahme des Standrohres, Auflageplatte, Haltebügel mit verborgenen Schrauben und Muttern; (halbe Befestigungspunkte) für 2 bis 6 Säuler, Einstellbereich 80 bis 110 mm, RAL 9016 für 2 bis 6 Säuler, Einstellbereich 80 bis 110 mm, andere Farbtöne für 2 bis 6 Säuler, Einstellbereich 110 bis 170 mm, RAL 9016 für 2 bis 6 Säuler, Einstellbereich 110 bis 170 mm, andere Farbtöne für 2 bis 6 Säuler, Einstellbereich 170 bis 290 mm, RAL 9016 für 2 bis 6 Säuler, Einstellbereich 170 bis 290 mm, andere Farbtöne	Z13DZ9522724000 Z13DZ952272700R Z13DZ9522725000 Z13DZ952272800R Z13DZ9522723000 Z13DZ952272600R	pro Stk. 25,94 33,71 27,14 35,28 28,20 36,65
	Fußplattenabdeckung für SK2 und FK5 für Fertigfußbodenmontage, einteilig, Kunststoff weiß	Z13DZ9522401000	pro Stk. 5,46





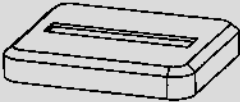
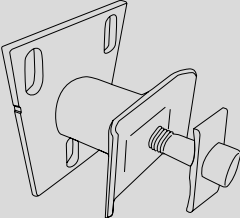
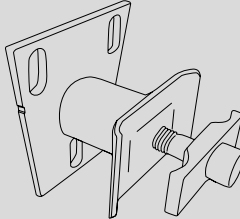
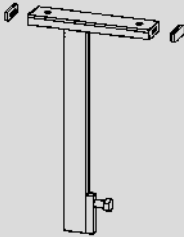
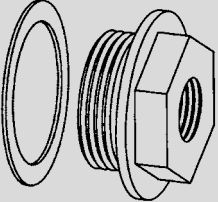
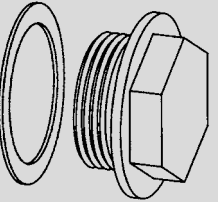

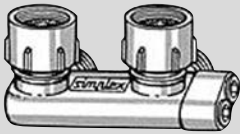

Die Befestigungspunkte der Aufhängungen finden Sie in der Technik auf den Seiten 262 bis 264. Für Standkonsolen gelten die halben Befestigungspunkte.

Druckfehler, technische und preisliche Änderungen vorbehalten. Unverbindliche Preisempfehlung exkl. MwSt. gültig ab 1.2.2016.
 Achtung: Für jede Produktgruppe gelten unterschiedliche Rabattsätze.

ZUBEHÖR			
Abbildung	Artikelbezeichnung	Bestell-Nr.	Preis EUR
	<p>Standrohrabdeckung für SK2 und FK5</p> <p>für Rohfußbodenmontage, zweiteilig, Kunststoff weiß, zur Abdeckung des Standkonsolenrohres</p> <p>35 x 10 mm bei Standkonsolenrohr</p>	Z13DZ9522405000	<p>pro Stk.</p> <p>2,89</p>
	<p>Fußrohrabdeckung für SK2 und FK5</p> <p>für Rohfußbodenmontage, zweiteilig, Kunststoff weiß, zur Abdeckung des Standfußführungsrohres</p> <p>40 x 15 mm Standkonsolenführungsrohr</p>	Z13DZ9522402000	<p>pro Stk.</p> <p>2,89</p>
	<p>Wandkonsole WK 155 für Bauhöhe 155 mm</p> <p>zum Anschrauben an die Wand, aushebesicher, Wandabstand 40 mm; Belastung bis 250 kg;</p> <p>WK 155 S2, für 2-Säuler, RAL 9016 WK 155 S3, für 3-Säuler, RAL 9016 WK 155 S4, für 4-Säuler, RAL 9016 WK 155 S5, für 5-Säuler, RAL 9016 WK 155 S6, für 6-Säuler, RAL 9016 WK 155 S2, für 2-Säuler, andere Farbtöne WK 155 S3, für 3-Säuler, andere Farbtöne WK 155 S4, für 4-Säuler, andere Farbtöne WK 155 S5, für 5-Säuler, andere Farbtöne WK 155 S6, für 6-Säuler, andere Farbtöne</p>	<p>Z13DZ9521662000 Z13DZ9521663000 Z13DZ9521664000 Z13DZ9521665000 Z13DZ9521666000 Z13DZ952167200R Z13DZ952167300R Z13DZ952167400R Z13DZ952167500R Z13DZ952167600R</p>	<p>pro Stk.</p> <p>29,34 29,34 29,34 29,34 29,34 38,14 38,14 38,14 38,14 38,14</p>
	<p>Wandkonsole für öffentliche Bereiche (Schulen usw.)</p> <p>zum Anschrauben an die Wand, aushebesicher, robuste Ausführung; Wandabstand 40 mm; für senkrechte Belastung bis 250 kg;</p> <p>WK S2 - S6, für 2- bis 6-Säuler, RAL 9016 WK S2 - S6, für 2- bis 6-Säuler, andere Farbtöne</p>	<p>Z13DZ9521640000 Z13DZ9521642000</p>	<p>pro Stk.</p> <p>23,82 30,96</p>
	<p>Fensterbankträger FT2</p> <p>zur Aufnahme im Standrohr der Standkonsole SK2, fertiglackiert, höhenverstellbar bis 180 mm</p> <p>Länge 160 mm, RAL 9016 Länge 160 mm, andere Farbtöne Länge 200 mm, RAL 9016 Länge 200 mm, andere Farbtöne</p>	<p>Z13DZ9522403000 Z13DZ952250300R Z13DZ9522404000 Z13DZ952250400R</p>	<p>pro Stk.</p> <p>21,19 27,55 23,68 30,78</p>
	<p>Gewindestopfen mit Stopfendichtung</p> <p>RAL 9016</p> <p>Linksgewinde 1" x 3/8" Linksgewinde 1" x 1/2" Linksgewinde 1" x 3/4" Rechtsgewinde 1" x 3/8" Rechtsgewinde 1" x 1/2" Rechtsgewinde 1" x 3/4"</p>	<p>Z13DZ8820123000 Z13DZ8820125000 Z13DZ8820127000 Z13DZ8820124000 Z13DZ8820126000 Z13DZ8820128000</p>	<p>pro Stk.</p> <p>6,32 6,32 6,32 6,32 6,32 6,32</p>
	<p>Gewindestopfen blind mit Stopfendichtung</p> <p>RAL 9016</p> <p>Linksgewinde 1" Rechtsgewinde 1"</p>	<p>Z13DZ8820121000 Z13DZ8820122000</p>	<p>pro Stk.</p> <p>4,26 4,26</p>

Zubehör

ZUBEHÖR			
Abbildung	Artikelbezeichnung	Bestell-Nr.	Preis EUR
	Radiatornippel zum Verbinden („Nippeln“) von Radiatorblöcken mit 1“ Gewinde	Z13DZ8820230000	pro Stk. 2,31
	Nippelflachdichtung 1“	Z13DZ8820210000	4,17
	Nippelstangen mit SW 19 Aufnahme (Sechskant) Länge 1000 mm, 1“; zum Nippeln für Blöcke mit bis zu 19 Gliedern Länge 1600 mm, 1“; zum Nippeln für Blöcke mit bis zu 30 Gliedern Länge 2200 mm, 1“; zum Nippeln für Blöcke mit bis zu 40 Gliedern	Z13DZ8810313000 Z13DZ8810314000 Z13DZ8810315000	240,-- 270,-- 290,--
	Drehmomentschlüssel inkl. Verlängerung und Nuss SW 19	Z13DZ8810309000	65,--
	Adapter 1“ für Anschluss 1“ x 1“ mit Stopfendichtung verzinkt (Innengewinde ist immer Rechtsgewinde) Linksgewinde 1“ x 1“ Rechtsgewinde 1“ x 1“	Z13DZ8820150000 Z13DZ8820140000	13,65 13,65
	Radiatorstopfenschlüssel (Kunststoff)	Z13DZ8820240000	13,54
	Handtuchstange passend zu Laserline Röhrenradiatoren, bestehend aus einer Handtuch-stange 30 x 10 mm, mit zwei verchromten Halterungen, Bautiefe 45 mm, Länge nach Wunsch 300 bis zu 1000mm (Baulänge 6 bis 20 Glieder); Bestell.Nr. Beispiel: Z13DZ812125 06 00 = 6 Glieder, RAL 9016 Z13DZ812115 20 0R.... = 20 Glieder, andere Farbtöne	Z13DZ812125_..00 Z13DZ812115_..0R	105,53 120,61
	Reinigungsbürste zum bequemen Reinigen der Radiatoren 2-armig	Z13DZ8810219000	43,10
	Ventileinsatz für Laserline Ventil-Röhrenradiatoren Adapteraufnahme-gewinde M 30 x 1,5 mm	Z13DZ8828321000	24,55

ZUBEHÖR			
Abbildung	Artikelbezeichnung	Bestell-Nr.	Preis EUR
	Kreuzungsstück Durchgangsform G 3/4 I.G. - G 3/4 A.G. absperbar, Rohrabstand 50 mm - für vertauschten Vor- und Rücklaufanschluss	Z0CP00GG00010T0	Achtung: Rabattgruppe Zubehör Heizkörper Preise auf Seite 30
	Kreuzungsstück Eckform G 3/4 I.G. - G 3/4 A.G. absperbar, Rohrabstand 50 mm - für vertauschten Vor- und Rücklaufanschluss mit Übergangsstück G 1/2 A.G. - G 3/4 A.G. (selbstdichtend)	Z0CP00GG00010A0	
	Übergangsstück 1/2" A.G. - 3/4" A.G. für Einrohrhahnblock selbstdichtend, für die direkte Anbindung von Kupferrohren, Präzisionsstahlrohren und Kunststoffrohren	Z0MV000A1002000	
	Einzelkugelhahn G 3/4 I.G. - G 3/4 A.G. (selbstdichtend) in Durchgangsform für Klemmverschraubungen	Z0SB00GG00020T0	Achtung: Rabattgruppe Zubehör Heizkörper Preise auf Seite 29
	Einzelkugelhahn G 3/4 I.G. - G 3/4 A.G. (selbstdichtend) in Eckform für Klemmverschraubungen	Z0SB00GG00020A0	
	Einzelkugelhahn G 3/4 I.G. - G 1/2 I.G. (selbstdichtend) in Durchgangsform für 1/2" Stahlrohre	Z0SB00VG00020T0	
	Einzelkugelhahn G 3/4 I.G. - G 1/2 I.G. (selbstdichtend) in Eckform für 1/2" Stahlrohre	Z0SB00VG00020A0	
	Einrohrverteiler G 3/4 I.G. - G 3/4 A.G. (selbstdichtend) in Durchgangsform für Klemmverschraubungen	Z0SP00GG00010T0	
	Einrohrverteiler G 3/4 I.G. - G 3/4 A.G. (selbstdichtend) in Eckform für Klemmverschraubungen	Z0SP00GG00010A0	

Zubehör

ZUBEHÖR			
Abbildung	Artikelbezeichnung	Bestell-Nr.	Preis EUR
	Übergangsstück 1/2" AG - 3/4" AG für Zweirohrhahnblock mit O-Ring, Messing	Z03TP0040013300	Achtung: Rabattgruppe Zubehör Heizkörper Preise auf Seite 29/30
	Zweirohrhahnblock in Durchgangsform G 3/4 I.G. - G 3/4 A.G. HK-Anschluss 3/4" AG Eurokonus, Messing vernickelt, Regulier- und Schließfunktion	Z03TP004001320J	
	Zweirohrhahnblock in Eckform G 3/4 I.G. - G 3/4 A.G. HK-Anschluss 3/4" AG Eurokonus, Messing vernickelt, Regulier- und Schließfunktion	Z03TP004001310J	
	Design-Abdeckrosette für Zweirohrhahnblock Eckform, 50 mm Achsabstand weiß verchromt	Z0MV000C2001000 Z0MV000C200100H	
	Design-Abdeckrosette für Zweirohrhahnblock Durchgangsform, 50 mm Achsabstand weiß verchromt	Z0MV000C2101000 Z0MV000C210100H	

ZUBEHÖR FÜR LASERLINE TWIN UND FÜR LASERLINE STANDARD MIT SONDERANSCHLÜSSEN NACH UNTEN MITTIG

ZUBEHÖR			
	Ventil-Anschlussarmatur Ein- und Zweirohr Eckform geeignet für LL-Standard mit Sonderanschlüssen nach unten mittig mit Übergangsstück 1/2" A.G. - 3/4" A.G. selbstdichtend Einrohr Zweirohr	Z1SP00GG00010A0 Z1TP00GG00010A0	Achtung: Rabattgruppe Designheizkörper und -zubehör Preise auf Seite 132
	Ventil-Anschlussarmatur Ein- und Zweirohr Durchgang geeignet für LL-Standard mit Sonderanschlüssen nach unten mittig mit Übergangsstück 1/2" A.G. - 3/4" A.G. selbstdichtend Einrohr Zweirohr	Z1SP00GG00010T0 Z1TP00GG00010T0	
	Ventil-Abdeck-Rosette Eckform Eckform RAL 9016 Eckform diverse RAL-Farben Eckform diverse Sanitärfarben Eckform Chrom	Z1MV000C00010A0 Z1MV000C00010AR Z1MV000C00010AV Z1MV000C00010AH	
	Ventil-Abdeck-Rosette Durchgangsform Durchgangsform RAL 9016 Durchgangsform diverse RAL-Farben Durchgangsform diverse Sanitärfarben Durchgangsform Chrom	Z1MV000C00010T0 Z1MV000C00010TR Z1MV000C00010TV Z1MV000C00010TH	

BESTELLFORMULAR LASERLINE STANDARD

Firma: _____ Liefertermin: _____

Herr/Frau: _____

Bestell-Nr.: _____ Sondervereinbarung: _____

Lieferanschrift: _____ Interne Auftrags-Nr.: _____

ANSCHLUSSVARIANTEN LASERLINE STANDARD			
Anschlussvariante/Anschlusskürzel		Bezeichnung/Bemerkung	Mehrpreis in €
		Anschluss „gleichseitig“	0,00
		Anschluss „wechselseitig“	0,00
		Anschluss „reitend“	25,64
		Anschluss „oben-oben“	25,64
		Anschluss „von/nach unten“, 1. und 2. Glied	72,38
		Anschluss „von/nach unten“, 1. und letztes Glied	72,38
		„Mittenanschluss“ nur gerade Gliederanzahl möglich!	72,38
		Anschluss „von/nach oben“	72,38
		Anschluss „von/nach oben“, 1. und letztes Glied	72,38

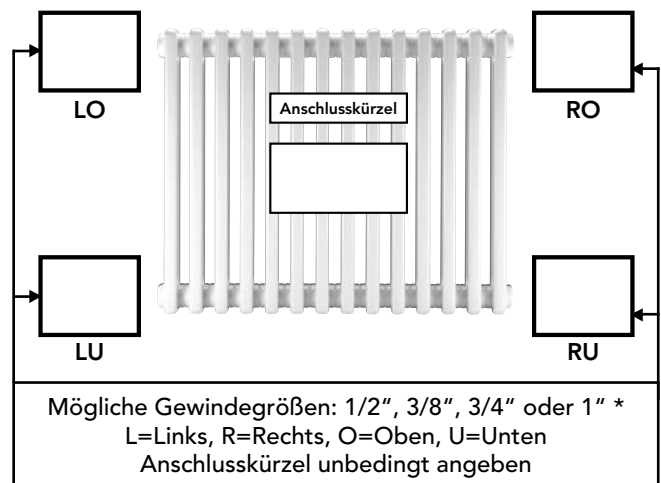

* 1" nicht geeignet für den direkten Anschluss an das Rohrleitungssystem; (ggf. mit 1" Adapter, 3/8", 3/4" als Gewindestopfen sowie 1/2" als Schweißdeckel oder Gewindestopfen)

Standardmäßig erfolgt die Auslieferung des LL-Standard ohne Laschen, d.h. die Heizkörper sind drehbar.

Stopfen-Set nicht im Lieferumfang enthalten, bitte separat bestellen.

Werden keine Gewindegrößen und keine Anschlussvariante bekanntgegeben, erfolgt die Auslieferung des LL-Standard mit 4 x 1/2"-Schweißdeckel. Mögliche Anschlussvarianten sind AB, FE, AE und FB

Anschlüsse nach oben und unten nur mit 1/2" I. G. möglich!

LASERLINE

Stück	Modell	Gliederanzahl	Anschlusskürzel	Ausführung/Gewindegrößen				Farbe	Befestigung	Bemerkung
				LO	LU	RO	RU			

BESTELLFORMULAR LASERLINE VENTIL-MITTE UND TWIN

Firma: _____ Liefertermin: _____

Herr/Frau: _____

Bestell-Nr.: _____ Sondervereinbarung: _____

Lieferanschrift: _____ Interne Auftrags-Nr.: _____

Wichtige Bestellangaben LL-Ventil-Mitte:

- Stück
- Modell
- Gliederanzahl (max. 30 Glieder bzw. laut Auflistung S. 247)
LL-Ventil-Mitte nur mit gerader Gliederanzahl möglich!
- Laschen **gegen Aufpreis** (Standard ohne Laschen ist drehbar!)
- Angabe der RAL- oder Sanitärfarbnummer
- Zubehör/Aufhängung

Achtung! Die Fertigungstoleranz der Baulänge beträgt 0 bis +1%. Berücksichtigen Sie diese bei der Vormontage!

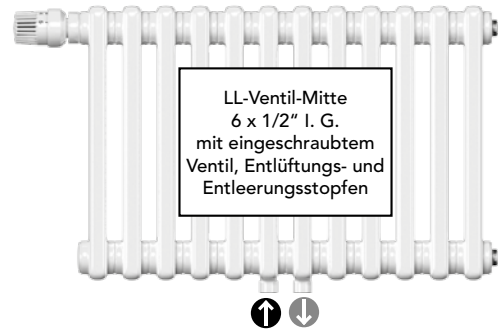

Wichtige Bestellangaben LL-Twin:

- Stück
- Modell
- Gliederanzahl (10 oder 12)
- LL-Twin wird mit Befestigungslaschen, Wandbefestigung und Handtuchstange ausgeliefert!
- Angabe der RAL- oder Sanitärfarbnummer
- Zubehör/PTC-Heizpatrone nur für LL-Twin möglich (gegen Aufpreis!)

Achtung! Die Fertigungstoleranz der Baulänge beträgt 0 bis +1%. Berücksichtigen Sie diese bei der Vormontage!

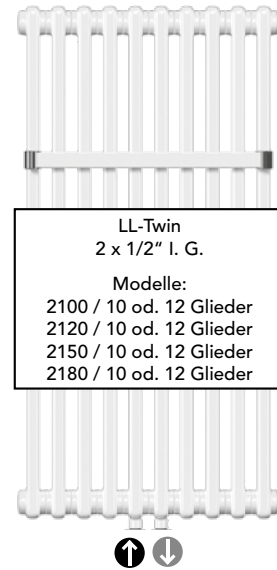

Stück	A= LL Ventil Mitte B= LL Twin	Modell	Gliederanzahl	Farbe	Befestigung	Bemerkung